

# *Dun Fhinn, Islay: excavation, woodland exploitation and building an Iron Age chronology for Argyll*

Article

Published Version

Creative Commons: Attribution-Noncommercial 4.0

Open access

Regan, R., Maričević, D. ORCID: <https://orcid.org/0000-0001-8647-6250>, Barnett, C. and Mithen, S. ORCID: <https://orcid.org/0000-0002-3391-7443> (2022) Dun Fhinn, Islay: excavation, woodland exploitation and building an Iron Age chronology for Argyll. *Proceedings of the Society of Antiquaries of Scotland*, 151. pp. 75-102. ISSN 2056-743X doi: <https://doi.org/10.9750/PSAS.151.1329> Available at <https://centaur.reading.ac.uk/108177/>

It is advisable to refer to the publisher's version if you intend to cite from the work. See [Guidance on citing](#).

To link to this article DOI: <http://dx.doi.org/10.9750/PSAS.151.1329>

Publisher: Society of Antiquaries of Scotland

All outputs in CentAUR are protected by Intellectual Property Rights law, including copyright law. Copyright and IPR is retained by the creators or other copyright holders. Terms and conditions for use of this material are defined in the [End User Agreement](#).

[www.reading.ac.uk/centaur](http://www.reading.ac.uk/centaur)

**CentAUR**

Central Archive at the University of Reading

Reading's research outputs online

# Dun Fhinn, Islay: excavation, woodland exploitation and building an Iron Age chronology for Argyll

Roddy Regan FSAScot,\* Darko Maričević FSAScot,†  
Catherine Barnett‡ and Steven Mithen FSAScot§

## ABSTRACT

*Duns are a problematic class of monuments for Argyll. They encompass an ill-defined and diverse range of structures, with limited evidence for their chronology and functions within late prehistoric and early historic society, settlement and economy. The Isle of Islay has a notably high concentration of duns, especially in its south-east region. We describe a small-scale excavation at one of these, Dun Fhinn, designed to establish the date of its construction and that of a circular internal structure, the latter proposed by the RCAHMS as a later addition. These are shown to have functioned at the same time in the later half of the 1st millennium BC, the roundhouse likely being an integral part of the original construction. Finds were limited to a few utilised stones, fragments of burnt clay and the rim of a wooden bowl, while the charcoal assemblage provides insights into the surrounding landscape and its exploitation for fuel. We consider the significance of Dun Fhinn for development of an Iron Age chronology for Argyll.*

## INTRODUCTION

Duns are arguably the most prominent but least understood type of dry-stone monument in Argyll. There is a paucity of knowledge about their chronology, function and role within prehistoric and early historic settlement, reflecting the scarcity of excavation (ScARF 2012, 2017). Islay epitomises the regional situation. The RCAHMS (1984) identified 49 ‘duns’ on the island, but there has been no fieldwork to establish when or why these were constructed. To begin addressing this situation, Islay Heritage (a charity registered in Scotland: SC046938), the

University of Reading and Kilmartin Museum undertook an exploratory excavation at Dun Fhinn, located in the south-east of Islay in the spring of 2018 (NGR NR 4425 5191, Canmore ID 38091, Site Number NR45SW 2; Illus 1). The objectives were to establish when the dun had been constructed, the relationship between an internal circular structure and the wall of the dun, and the extent of archaeological deposits, with a view towards developing a more extensive excavation should that be warranted. Prior to describing this work, we briefly summarise the current understanding of duns in Argyll to place the Dun Fhinn project within context.

---

\* Independent Researcher and Archaeologist, Argyll, UK

† Department of Archaeology, University of Reading, UK

‡ Stantec Department of Archaeology, University of Reading, UK

§ Department of Archaeology, University of Reading/Islay Heritage (SC046938) S.J.Mithen@reading.ac.uk



ILLUS 1 Dun Fhinn, Isle of Islay, viewed from the south, April 2017. Scale is provided by figures on the summit. (Image by Steven Mithen)

## DUNS IN ARGYLL

It is widely acknowledged that the ‘dun’ is a problematic category of archaeological site. The RCAHMS (1971: 18) defined a dun as a ‘comparatively small defensive structure with a disproportionately thick dry-stone wall, usually but not always sub-circular or oval in plan, and enclosing an area not exceeding about 375 square metres (400 square foot) it would thus normally hold only a single family’; this conflates description with interpretation, while imposing an arbitrary spatial area – with larger structures defined as forts. As a category, duns encompass structures that differ not only in size but also in shape and complexity (Alcock & Alcock 1987; Harding 1997; Gilmour 2000). The term ‘dun houses’ has been proposed for the smaller sites

(Harding 1984), while Gilmour (2000) adapted Armit’s (1991, 1992) Western Isles Atlantic Roundhouse nomenclature to encompass thick-walled monumental circular roundhouses in Argyll.

Two positions have developed about the chronology of duns. One proposes that duns primarily date to the 1st millennium AD, potentially providing an element of the Dál Riata settlement hierarchy (eg Alcock & Alcock 1987; Nieke 1990, 2004); the other proposes duns arose as an Iron Age development during the 1st millennium BC, albeit allowing for reuse in the Late Iron Age and the early medieval periods (eg Harding 1984, 1997; Gilmour 2000; Armit 2004).

The debate is lacking sufficient evidence to be resolved, although new data is gradually accumulating (Illus 2). For a long time, the only





ILLUS 2 Iron Age dry-stone sites with radiocarbon dates in Argyll. Duns: 1 – Dun Fhinn, Islay; 2 – Barnluasgan; 3 – Balure, Knapdale; 4 – Carnasserie, Mid Argyll; 5 – Kildonan Bay, Kintyre; Atlantic roundhouses: 6 – Dùn Mór Vaul, Tiree; 7 – Loch Glashan, Mid Argyll; Forts: 8 – Dunadd, Mid Argyll; 9 – Eilean an Duine, Mid Argyll; 10 – Balloch Hill, Kintyre. (Image by Darko Maričević)

radiocarbon-dated dun in Argyll was Kildonan Bay in Kintyre. Its 7th–9th century AD dates, however, were derived from secondary deposits, with the date of its construction being placed within the 1st–2nd century AD on the basis of artefactual evidence (Peltenburg 1982; Ritchie & Harman 1985).

More recently, a simple Atlantic roundhouse at Loch Glashan was dated to between the 4th and 1st century BC (Henderson & Gilmour 2011). That reinforced Gilmour's (2000) proposal that some irregular and perhaps most rectangular-shaped duns, such as Dùn Fhinn

(Campbeltown), Kildonan Bay and Eilean Rìgh 1, date to the 1st millennium AD, while circular duns, which might be termed Atlantic roundhouses, were constructed in the 1st millennium BC. Some irregular-shaped duns were considered to have possible Late Bronze Age origins.

Recently derived dates from three duns in mainland Argyll support that view, all falling within the second half of the 1st millennium BC: the dun structure at Carnasserie dates between the 4th and 1st century BC (Regan 2017); the dun at Barnluasgan falls between the 4th century BC and 1st century AD; and that at Balure dates

between the 2nd century BC and the 1st century AD (Regan 2008).

The limited data about the chronology of duns in Argyll is matched by that of associated monuments. The radiocarbon dates from Dùn Mór Vaul broch on Tiree have been a subject of much debate (MacKie 1974, 1997; Armit 1991) and are unlikely to be resolved in light of the size of their standard deviations (Ashmore 1997). Three forts have produced dates from across the 1st millennium BC – Eilean an Duin (Nieke & Boyd 1987), Balloch Hill (Peltenburg 1982) and Dunadd (Lane & Campbell 2000), the latter becoming a royal centre in the mid-1st millennium AD. Otherwise, forts within Argyll remain undated, providing a category of monument as diverse and as little understood as the duns.

A further issue concerns the role of duns within the prehistoric and/or early historic settlement pattern of Argyll. While duns often occupy topographic positions that are intuitively defensive in character, such as knolls and coastal promontories, and often have thick walls that support this role, they are also located close to land suitable for cultivation. From the sparse evidence available, such as from Rahoy (Nieke 1990), Balure (Regan 2017) and Dun An Fheurain, Gallanach (Ritchie 1970), domestic activities occurred within the duns and appear little different from those within Bronze Age hut-circles (eg Cul a'Bhaile, Stevenson 1984), crannogs (eg within Loch Learthan and Loch Awe, Cavers 2010) and forts (eg Dun Cul Bhuirg, Iona, Ritchie & Lane 1980; Balloch Hill, Peltenburg 1982).

## DUNS ON ISLAY

The absence of any dun excavations on Islay is surprising considering their prominence in the landscape, their significance having been noted by Childe (1934), and the extent of previous fieldwork on Islay (eg Mesolithic, Mithen 2000, Mithen et al 2015; Neolithic, Harrington & Pierpoint 1980; Bronze Age, MacKie 1976; and medieval, Caldwell & Ewart 1993, Mithen et al 2020). One exception is a dry-stone structure occupying a crannog at Eilean na Comhairle,

Finlaggan, which was found during the excavation of the late medieval buildings and deposits associated with the seat of the Lordship of the Isles. This was identified as the remains of a dun built sometime after the 6th century AD (Caldwell 2010).

The RCAHMS (1984) recorded 49 duns on Islay, along with 31 forts and one broch. Twenty-one of the duns are in the south and east of the island, providing one of the densest concentrations in Argyll; nine duns are in the centre of the island and 19 duns are found in the west. Nieke (1983) speculated that some or all of these duns might be a portion of the Dál Riata Kingdom houses described on Islay within the *Senchus fer nAlban*. Gilmour (2000: fig 9) and Armit (2004: map 10) recognise between 18 and 20 possible Atlantic roundhouses among Islay's duns, of which only Dun Bhoraraig broch and Dun Chroisprig galleried dun (Illus 3) can be confidently categorised as 'Complex Atlantic Roundhouses'.

Attention was drawn to the concentration of duns in the south-east of Islay by the Kintour Landscape Survey undertaken in the spring of 2017 ([www.islayheritage.org/kintour](http://www.islayheritage.org/kintour)). That involved a walk over and desk-top survey, primarily documenting deserted townships but noting a concentration of nine duns, five forts and a possible crannog within the study area (Illus 3). Their topographic locations are typical for Atlantic Scotland, being either on coastal promontories or on prominent ground, with relatively easy access to the coast, and situated close to cultivable land. The overall pattern is a string of duns and forts along the coast, with an inland line of sites following the geologically defined topography by running south-west/north-east and appearing to delineate the western extent of cultivable land. Further sites lie between these extremities. Within the survey area, and occupying the same stretch of coast, the promontory forts/duns at Trudernish, Dun nan Gall and Dun An Rubha Bhuidhe have traces of vitrification which are unknown on any of the inland forts and duns.

Of these duns, Dun Fhinn is notable for its prominence. The Ordnance Survey Name Book entry on Dun Fhinn states that the name

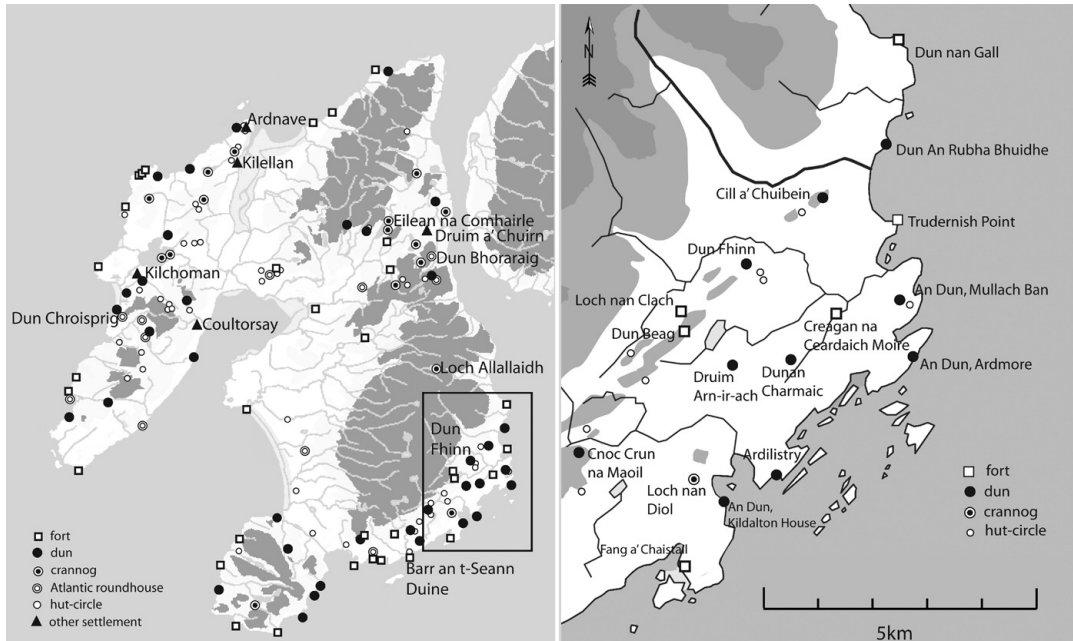

ILLUS 3 Left: Distribution of Iron Age sites on Islay showing the location of sites mentioned in the text. Right: Duns and associated sites in the south-east of Islay: Dun nan Gall (Canmore ID 38034); Dun An Rubha Bhuidhe (Canmore ID 38084); Trudernish Point (Canmore ID 38050); An Dun, Mullach Ban (Canmore ID 38053); An Dun, Ardmore (Canmore ID 38055); Ardilistry (Canmore ID 38033, etc); Cill a Chuibein (Canmore ID 38085); Dun Fhinn (Canmore ID 38091); Loch nan Clach (Canmore ID 38094); Dun Beag (Canmore ID 38095); Cnoc Crun na Maoil (Canmore ID 38009); Creagan na Ceardaich Moire (Canmore ID 38066); Dunan Charmaic (Canmore ID 38097); Druim Arn-ir-ach site (Canmore ID 38096). (Image by Darko Maričević)

means ‘Fingal’s Castle’ (Ordnance Survey Name Books, Argyll Name Books OS1/2/36/2) and there is a widely held local belief that the name derives from associations with Fhion mac Cumhaill (Finn MacCool), the legendary figure of Irish myth. A local story tells how he was fond of coming to Islay to relax, and how ‘At one time the people in Islay were being greatly harassed by the Lochlanners [Norsemen] and appealed to Fionn to come to their aid. This Fionn did, and he and his men soon cleared Islay of the invaders’ (Earl 1980: 11).

Dun Fhinn occupies a knoll that forms the north-east end of a prominent south-west/north-east orientated natural ridge named Leac Eidhne that runs west of the farms of Tallant and Kintour. It is 15m above moorland of rough grass, heather and bracken, with extensive views to the north,

east and west, but limited views to the south, suggesting its position references the lower extent of the Kintour River, rather than the higher ground to the west and south. Dun Fhinn is also notable for having a circular structure within the dun (RCAHMS 1984). Superficially, this appears to be a roundhouse, not dissimilar in size to four hut-circles located 400m to the south-west of Dun Fhinn. Surface inspection was unable to identify the relationship between the roundhouse and the surrounding wall of the dun, leaving open the possibility that it is a later insertion, as proposed by the RCAHMS, potentially of a medieval date.

Such internal structures are rarely found within duns and forts in Argyll. On Islay possible remnants of circular or sub-circular structures can be found within the forts of Creagan

na Ceardaich Moire (Canmore ID 38066), Dun Beag (Canmore ID 38095), Loch nan Clach (Canmore ID 38094) and possibly Barr An t-Seann Duine (Canmore ID 38001), all situated in the south of the island, although the exact nature of these remains can be clarified only by excavation. The closest comparison on Islay comes from the crannog at Loch Allalaidh (Canmore ID 38042), located *c* 6.5km north of Dun Fhinn. Here the artificial oval islet is enclosed by a substantial wall and contains a central roundhouse of similar dimensions to that at Dun Fhinn.

Considering the concentration of duns in the south-east of Islay, the prominence of Dun Fhinn and its internal roundhouse, a detailed survey followed by an exploratory excavation was undertaken in the spring of 2018.

#### DUN FHINN DESCRIPTION AND TOPOGRAPHIC SURVEY

A dry-stone wall surrounds the summit of the knoll, enclosing an oval-shaped area of 18m north-east/south-west and up to 11m wide. The dun's interior contains a near-circular structure measuring between 6.0 and 6.40m in internal diameter with walls up to 1.20m wide and standing up to 0.60m above the present ground surface (Illus 4 & 5). Gaps in the walling on the north-east and north-west sides suggest entrances.

The dun wall varies in width, reaching 2m on the north-west side and up to 3.5m wide on the north-east side, as indicated by large in situ inner and outer facing-stones. The outer wall facing is best preserved on the north and north-west (Illus 6) and south-west (Illus 7) sides, where



ILLUS 4 Dun Fhinn, showing location of Trenches 1 and 2. (Image by Roddy Regan and Rob Fry)



ILLUS 5 The summit of Dun Fhinn, looking north. (Image by Steven Mithen)



ILLUS 6 The facing-stones on the north-west side of the dun. (Image by Roddy Regan)



ILLUS 7 The facing-stones on the south-west side of the dun. (Image by Roddy Regan)



ILLUS 8 The lower outwork facing-stones with the distorted facing-stones of the dun wall above. (Image by Roddy Regan)

the wall stands to between 1.10m and 1.80m in height above present ground levels. Wall debris covers much of the knoll on its south-east side, although survey and excavation revealed that the dun had a massively built wall on this side measuring up to 3.4m wide.

This width appears to be a response to the underlying geology that slopes downwards to the south-east in a series of uneven steps, requiring a wide base to be constructed to support a wall of any significant height. It is possible that the outer wall face may have originally been battered. The wall of the dun bifurcates at its southern end, the outer wall section branching down towards the foot of the knoll to form a curving outwork

around the entrance to the dun (Illus 4 & 8). The facing of the upper outer dun wall can be traced, although it has been much distorted by subsidence/collapse. The entrances through the outwork and the upper/inner dun wall are blocked by fallen debris, although rubble appears to have been cleared from the sidewalls of the outwork entrance passage to suggest it had a width of 2.7m (Illus 9 & 10). The upper entrance passage appears narrower, but without clearance this remains uncertain.

Hollows and uneven ground on the outside of the dun entrance on the south-west side may represent small structures, as suggested by the RCAHMS, but these are too amorphous to





ILLUS 9 The rubble-filled lower entrance through the dun outwork. (Image by Roddy Regan)



ILLUS 10 Facing-stones of the eastern side of the entrance. (Image by Roddy Regan)

reach any definite conclusion without excavation. A sub-circular structure lies below the dun on the north-east side. This might either represent a shieling or be related to quarrying that has evidently occurred along the surrounding escarpment.

A topographic survey of Dun Fhinn and the surrounding landscape was conducted over three days using a Leica GS09/CS09 GNSS SmartNet. A higher resolution survey (0.5m) across the summit was also undertaken, enabling the finer detail of the topography and upstanding archaeology within this area to be exposed, especially the overgrown remains of the roundhouse (Illus 11).

## EXCAVATION

Two areas of excavation were opened within the dun, Trenches 1 and 2 (Illus 4).

### TRENCH 1

The aim of the trench was to understand the relationship of the roundhouse to the dun wall, secure material for radiocarbon dating, and evaluate the character of archaeological deposits to assess the worth of a more extensive excavation. A trench was extended north-west from the south-eastern side of the dun wall (Context 006), running across

the south-eastern side of the roundhouse wall (C005) and into the internal space of this structure (Illus 12). The distance between the walls of the dun and the roundhouse ranged between 2m to just above 1m at its narrowest point within the trench; this proximity is repeated at the opposite, north-west, side of the dun. Two discrete depositional sequences were encountered: one between the walls of the two structures and one providing the internal stratigraphy within the roundhouse (Illus 13).

### *Outside the roundhouse*

Below the peaty overburden/topsoil (C001) there were stones (C018) that appeared to be recent collapse from the wall (C006) and a mixed deposit of silty-peat (C002) containing charcoal, from which a sample was later selected for radiocarbon dating, SUERC-95432 (Table 1). This deposit covered rubble (C004) contained within a light brown soil (Illus 14), and with numerous voids suggesting the stones had been rapidly deposited, although its upper extent had the appearance of a cobbled or trampled surface. This overlies a second rubble deposit (C013), which at its lower level lay within a brown silt that contained charcoal. This could be only partially excavated because some of its larger stones extended into the section while the removal of others would have destabilised the roundhouse wall (Illus 15). The unexcavated stones of C013 sloped down

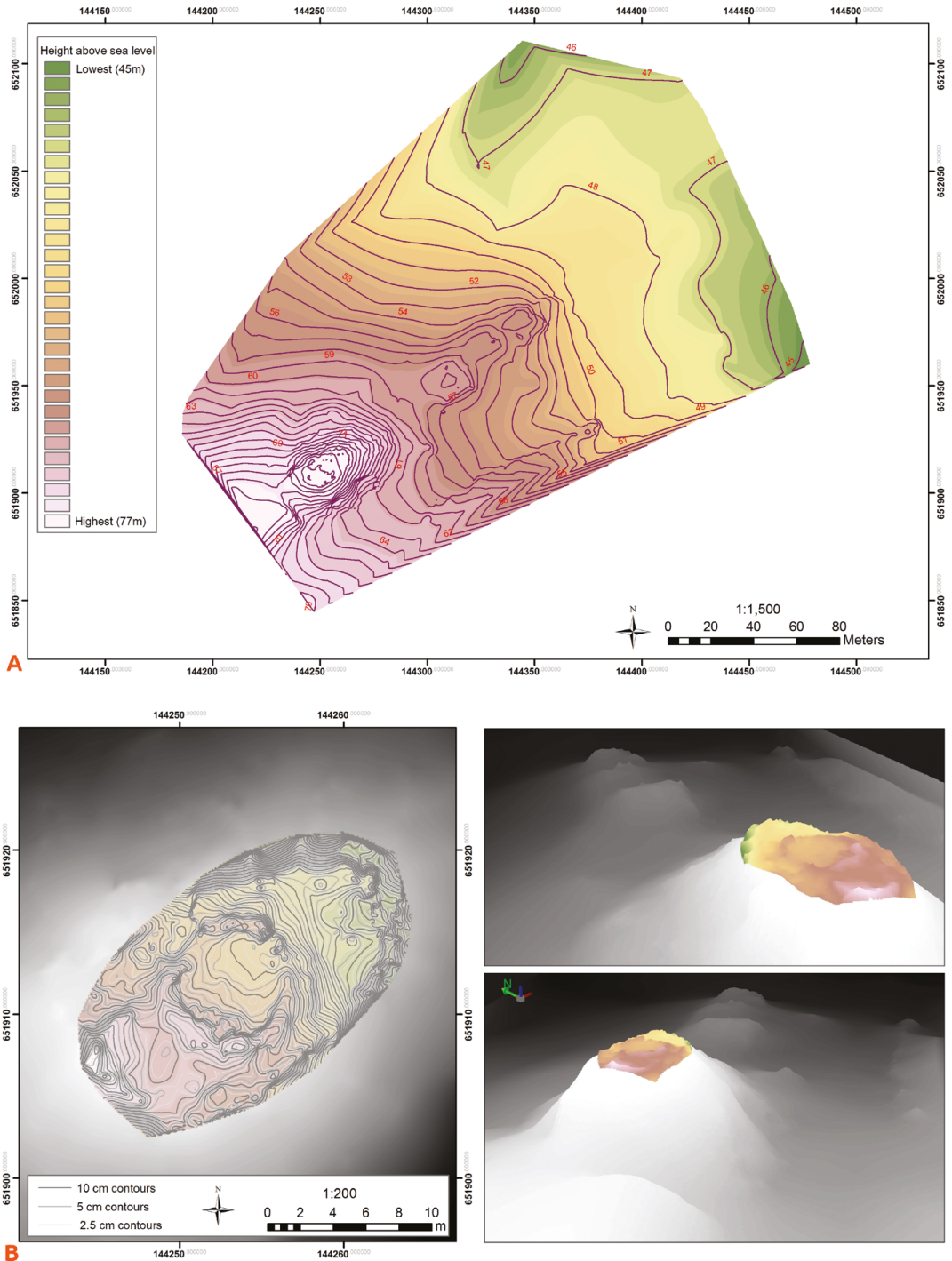

ILLUS 11 Topographic survey of Dun Fhinn: (a) surface and contour map of survey; (b) detailed micro-topography of the plateau compared to the immediate landscape. (Survey by Rob Fry)





ILLUS 12 Trench 1, looking south-west, with Trench 2 beyond. (Image by Darko Maričević)

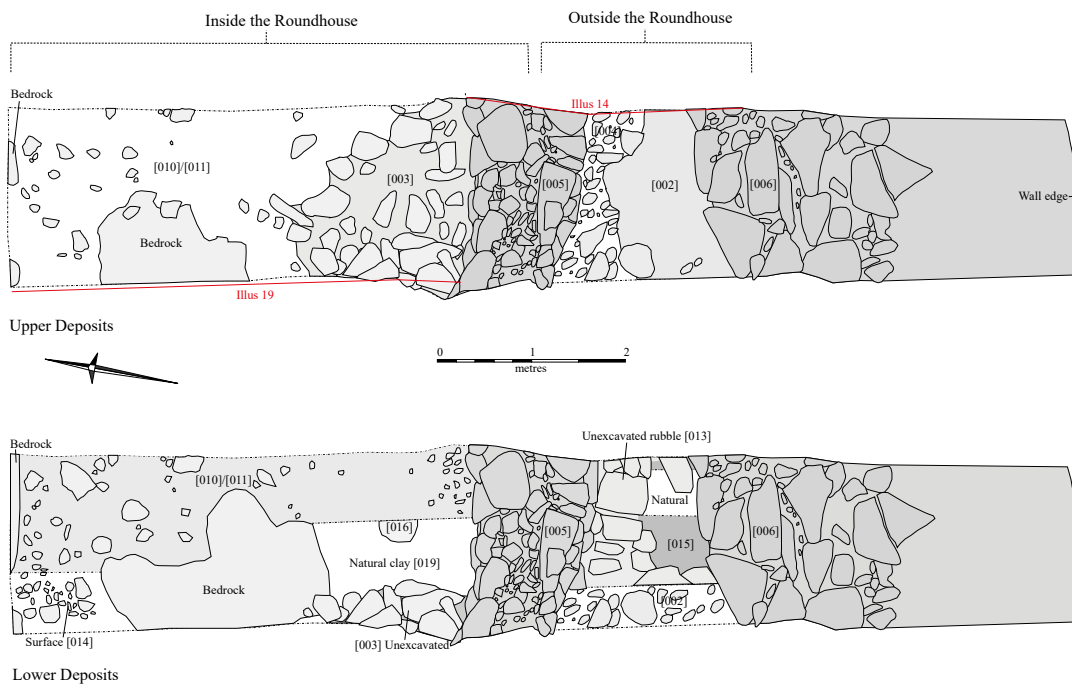

ILLUS 13 The upper and lower deposits within Trench 1. (Image by Roddy Regan)



ILLUS 14 Surface of rubble (C004) between the dun and roundhouse walls from the east. (Image by Roddy Regan)

distinctly from the north-west to the south-east, suggesting they lay against the roundhouse wall (C005, Illus 16).

Where the rubble could be removed, it exposed a dark brown silt (C015) containing occasional charcoal pieces, from which a sample was later selected for radiocarbon dating, SUERC-95425 (Table 1). This deposit also contained degraded fragments of fired clay. Deposit C015 lay over the internal wall face of the dun (C006) and bedrock (C020) that was exposed 1.09m below the present ground surface. At this depth, the narrowness of the trench prevented observation of the contact between the base of the wall and bedrock. The internal face of the wall had been constructed from large angular stone blocks, these possibly quarried from the bedrock and levered into position.

#### *Inside the roundhouse*

Removal of the vegetation and associated peat (C001) revealed the roundhouse wall (005, Illus 17 & 18) and exposed natural bedrock to the north-west of the wall face, in the central area of the roundhouse and at the extreme west end of the trench (Illus 12 & 23). Below the topsoil at the west end of the trench, a dark grey deposit (C010) was exposed that contained carbonised plant material, from which a sample was later selected for radiocarbon dating, SUERC-95431

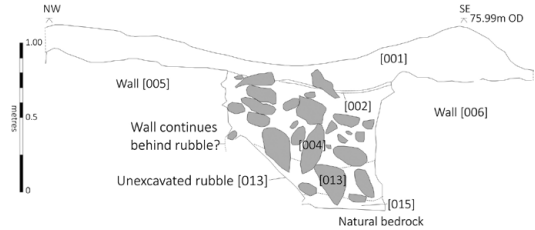

ILLUS 15 Section between the roundhouse (C005) and dun (C006) walls. (Image by Roddy Regan)



ILLUS 16 External face of roundhouse wall (C005) from the south-west. (Image by Roddy Regan)

(Table 1). Below, there was a similar dark grey deposit (C014), its upper extent compacted, suggesting its use as a rough surface, although this was not excavated (Illus 13).

Below C001 at the south-east, there was a horizon of rubble within a red brown peaty silt which also contained voids (C003), interpreted as collapse of the roundhouse wall (Illus 19 & 20). At least four courses of walling had either collapsed or been pushed over into the roundhouse interior, indicating that the dry-stone base of the wall originally stood higher. This wall collapse sealed a dark grey deposit (C011), which contained fragments of carbonised plant material along with one fragment of fired clay (SF1) and two utilised pebbles (SF2 and SF3). This deposit likely equates to deposit C010. Where this deposit lay against the roundhouse wall (C005) it contained more stones and gave the appearance of having been utilised as a rough surface. Below



TABLE 1  
Radiocarbon dates from Dun Fhinn

<i>Ref no. / Context</i>	<i>Context description</i>	<i>Species (all wood charcoal)</i>	<i>Lab code</i>	<i>Uncalibrated BP</i>	<i>OxCal v4 IntCal20 calibration</i>
032 (015)	Early deposit, the dun	<i>Corylus avellana</i> roundwood	SUERC-95425	2355 ± 27	516–385 (95.4%) cal BC
011 (009)	Occupation deposit	<i>Quercus</i> sp roundwood	SUERC-95426	2407 ± 27	731 (5.9%) 700 cal BC
					664 (3.2%) 650 cal BC
					546 (86.4%) 401 cal BC
023 (012)	Early deposit, roundhouse	<i>Betula</i> sp	SUERC-95430	2389 ± 27	717 (1.1%) 710 cal BC
					659 (0.8%) 655 cal BC
					545 (93.6%) 397 cal BC
015 (010)	Later deposit, roundhouse	<i>Betula</i> sp	SUERC-95431	2128 ± 27	344 (8.4%) 320 cal BC
					202 (87.1%) 53 cal BC
001 (002)	Collapse/demolition deposit	<i>Corylus avellana</i> twigwood	SUERC-95432	363 ± 27	1455 (48.7%) 1529 cal BC
					1551 (46.7%) 1634 cal BC



ILLUS 17 Internal face of roundhouse wall (C005) from the north-east. (Image by Roddy Regan)

this was a darker grey silt deposit (C012), which appeared relatively rich in charcoal compared to the overlying C011 (Illus 21), and from which a sample was later selected for radiocarbon dating, SUERC-95430 (Table 1).

Deposit C012 sealed bedrock, the base of the internal wall of the roundhouse (C005) and a light grey/white clay (C019), which had a sub-circular



ILLUS 18 Roundhouse wall (C005) from the east. (Image by Roddy Regan)

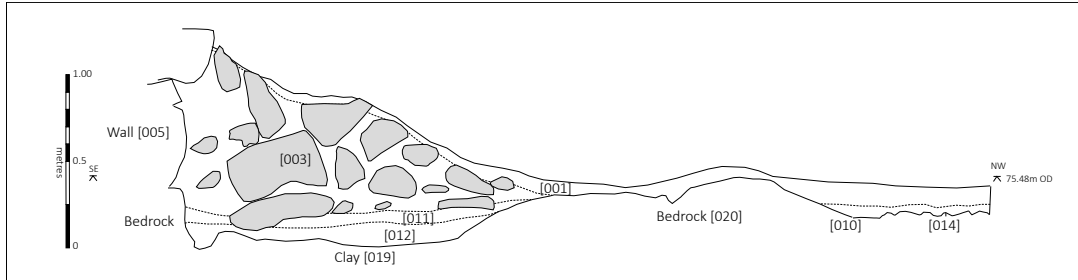

ILLUS 19 Section through roundhouse deposits. (Image by Roddy Regan)



ILLUS 20 Rubble (C003) within roundhouse from the north. (Image by Roddy Regan)



ILLUS 21 Deposits (C012) and (C011) against roundhouse wall (C005), from the north. (Image by Roddy Regan)



ILLUS 22 Burnt deposit (C016) on clay (C019), from the east. (Image by Roddy Regan)

patch of harder material at the eastern end of the trench (C016), coloured red brown and which may represent a patch of burning (Illus 21). The

internal wall of the roundhouse had been constructed with large blocks of stone to provide the facing-stones of the wall, with smaller stones used as internal packing (Illus 22). A large rectangular block of natural bedrock (C020) had been utilised for the basal course for the wall. The bedrock was higher than that encountered in the trench to the east, suggesting a drop-off in that direction. If this slope was uneven, it may account for the rather rough coursed appearance of the roundhouse wall on its external face, arising from slippage.

#### TRENCH 2

This trench was designed to examine the nature of a linear ‘hump’ that appeared to represent a possible wall line, given that the ground dropped off





ILLUS 23 Section against internal face of roundhouse wall (C005) from the east. (Image by Roddy Regan)



ILLUS 25 Exposed surface of C009, from the east. (Image by Roddy Regan)

sharply beyond it to the west (Illus 3 & 4). Lifting of the topsoil (C001) quickly revealed the hump to be a natural accumulation of vegetation and peat (C007) sitting directly over a ridge of bedrock (C021). To the west of the trench were some large stones (C017), evidently collapse from the dun wall (C006), although no wall face was positively identified in the trench. Bedrock was also encountered within the eastern part of the trench. Sediment had accumulated within a natural dip in this bedrock. This contained a thin layer of very dark grey silt (C008), which partially covered the bedrock and contained relatively large fragments of wood charcoal (Illus 23). This layer was over a

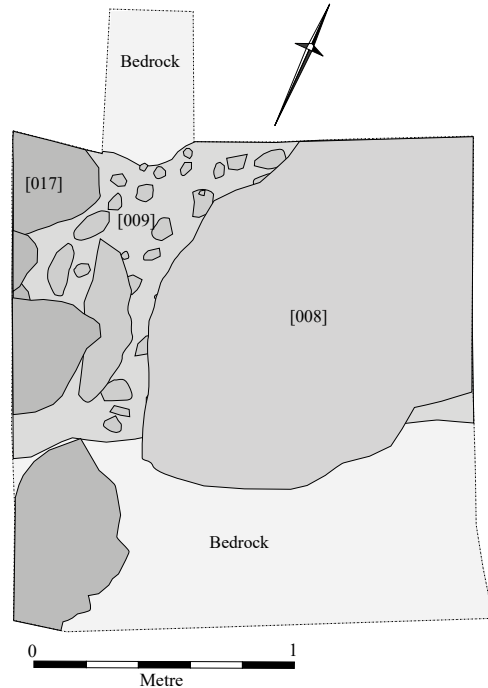

ILLUS 24 Lower deposits within Trench 2. (Image by Roddy Regan)

dark grey deposit (C009) that had frequent stone inclusions, giving the appearance of a trampled surface (Illus 24 & 25). It contained charcoal, from which a sample was later selected for radiocarbon dating, SUERC-95426 (Table 1).

## THE ARTEFACTS

A fragment of pottery or fired clay (SF1) and two large pebbles or small water-rounded cobbles (SF2 and SF3) were recovered from within the roundhouse (C011). The fabric of the fired clay is coarse with only one surface appearing fired; it is yellow/buff in colour and reduced dark grey internally. While it may be part of a coarse pottery vessel, a more likely interpretation is that it derives from clay structural material that has been heat affected. SF2 is an oval-shaped mottled grey quartzite pebble (L: 86mm; W: 56mm; Th: 33mm) with a band of quartz running through it. One side is particularly smooth, suggesting

its use as a smooth-stone or polisher. SF3 is an oval-shaped light grey quartzite pebble (L: 122mm; W: 67mm; Th: 30mm) with one side flat and smooth, the smoothness likely accentuated through use as a polisher smooth-stone. Both ends show damage, suggesting its use as a hammerstone. Three further pieces of utilised stone were also recovered from within the roundhouse (C010): a small fragment of quartz (C010) (L: 20mm; W: 19mm; Th: 16mm); a spall or flake of grey quartzite pebble (L: 52mm; W: 37mm; Th: 7mm); and a fragment of mottled quartzite pebble (L: 32mm; W: 20mm; Th: 20mm).

From the area between the roundhouse and the dun wall, five small fragments of fired clay were recovered (C015), all of which had only one apparent fired surface. The only other find was a large fragment of carbonised wood (SF4, C013) that resembles the rim of a wooden vessel (Illus 26). This is sub-rectangular with maximum dimensions of 38mm × 28.5mm × 12.5mm thick. It has a smooth outer surface with facets, suggesting it was carved and then smoothed. The inner surface is irregular, and the edge has been rounded and smoothed. Although the surface remains obscured by silt and sand, fine fibrous structures (possible multi-seriate rays) and possible rows of vessels are evident that suggest large oak, but a positive identification cannot be made without cutting. We suspect it is a carbonised fragment from the wooden rim of a slightly interned bowl, trough or bucket. Moulded or

turned wooden vessels have been recovered from a few Iron Age crannog sites in Scotland, including Lochlea (Munro et al 1879), Oakbank (Dixon 1981) and most recently Black Loch of Myrton (Cavers & Crone 2019, 2020). Further afield, similar but earlier wooden bowls were found in the Wilsford Shaft (Ashbee et al 1989: fig 51:12) and at the Heathrow T5 (Framework Archaeology 2010, vol 2: fig 37), both dating to the mid-2nd millennium BC, and a plethora of items have been reported from the recent excavation at Must Farm (Must Farm 2016). On Islay itself, a number of wooden objects were found in the 1960s during peat cutting at Srath Mor and Allt Garadh Ealabais, both to the west of Loch Gruinart (Newall 1963; Earwood 1998). A number of the reported items have been lost or were never fully recovered and the contextual information is largely lacking. A wooden box from Srath Mor and a tub from Allt Garadh Ealabais have been radiocarbon dated to 1510–1260 cal BC and 1062–761 cal BC, respectively (Earwood 1998).

#### THE WOOD CHARCOAL

Bulk samples were taken from several deposits during excavation of Dun Fhinn. Following processing by flotation, wood charcoal was sorted from the flots and residues. Identification of fragments >2mm was attempted, up to a count of 100

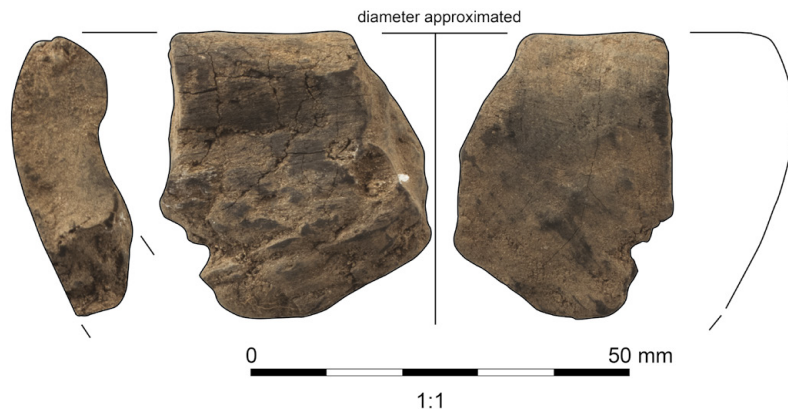

ILLUS 26 Rim fragment of wooden bowl. (Image by Sarah Lambert-Gates)

identifications per sample. Fragments were prepared for identification according to the standard methodology as described in Appendix 1. Eight samples were analysed, containing a total assemblage of 534 charcoal fragments.

Preservation was generally good, but a small proportion of the fragments were unidentifiable due to vitrification, appearing glassy. This phenomenon was once thought to be a sign of exposure to high temperatures (>800°C, Prior & Alvin 1983) but the causal processes are now considered unclear (McParland et al 2010). The material from C008, an occupation deposit within the dun, displayed a high proportion of pieces with mineral impregnation.

As shown in Tables 2 and 3, a minimum of nine taxa were found, and some of the higher taxonomic groupings might represent one or more species of similar anatomy (eg members of the Maloideae and Ericaceae families).

#### TRENCH 1, FROM OUTSIDE THE ROUNDHOUSE

Two samples of charcoal were examined from the stratigraphic sequence outside of the roundhouse. Deposit C002 was described onsite as silty-peat material on top of the collapsed/

demolition level of the dun wall. The charcoal assemblage comprised numerous young twig fragments, often only 1mm diameter and 1–2 years old when cut, and therefore having no diagnostic anatomical features to allow identification (63% unidentifiable twigwood). The identifiable proportion was heavily dominated by <5-year-old Ericaceae twigs. This group includes heather (*Calluna vulgaris*) and lings (*Erica* sp) at 34%. Morphologically these are similar to the unidentifiable fragments and it is assumed that they too were of Ericaceae. Two fragments of young hazel (*Corylus avellana*) twigwood were also found. Several Ericaceae fragments showed markedly twisted anatomy, which appeared artificial and could only have occurred before charring and when wet. Deliberate twisting and weaving suggests this deposit might represent collapse from heather roofing. A piece of *Corylus avellana* twigwood was selected for radiocarbon dating, SUERC-95432 (Table 1).

From below C002, a sample of charcoal was analysed from C013, a dump or collapse of schist rubble between the wall of the dun and the roundhouse. Hazel was the dominant taxon at 34%, with birch at 26% and oak (*Quercus* sp) at 18%. Wetland taxa were common, with alder

TABLE 2  
Wood charcoal from Dun Fhinn

Family	Sub-family	Genus/species	Common name
Fagaceae		<i>Quercus</i> sp ( <i>Q. robur/petrea</i> )	Oak
Betulaceae		<i>Alnus glutinosa</i>	Common alder
		<i>Betula pendula/pubescens</i>	Silver/downy birch
		<i>Corylus avellana</i>	Hazel
Salicaceae		<i>Salix/Populus</i> sp	Willow/aspen (the two are anatomically indistinguishable)
Ericaceae		<i>Calluna vulgaris</i> and/or <i>Erica</i> sp	Common heather
Rosaceae	Maloideae (formerly Pomoideae)	(Maloideae)	Pomaceous fruits, eg apple, pear, whitebeam, hawthorn
Aquifoliaceae		<i>Ilex aquifolium</i>	Holly
Caprifoliaceae		cf <i>Sambucus nigra</i>	Elder



TABLE 3  
Genus/species represented in Dun Fhinn charcoal

Genus/species	Context no.								Total	Ubiquity
	C002	C008	C009	C010	C011	C012	C013	C015		
<i>Alnus glutinosa</i>	0	0	0	0	3	2	8	15	<b>28</b>	<b>4</b>
<i>Alnus glutinosa</i> roundwood	0	0	0	0	0	0	0	5	<b>5</b>	<b>1</b>
<i>Betula pendula/pubescens</i>	0	0	2	9	12	72	20	32	<b>147</b>	<b>6</b>
<i>Betula</i> roundwood	0	0	0	0	0	0	6	0	<b>6</b>	<b>1</b>
<i>Corylus avellana</i>	0	16	2	5	7	19	24	22	<b>95</b>	<b>7</b>
<i>Corylus avellana</i> roundwood and twigwood	2	0	0	0	0	2	10	6	<b>20</b>	<b>1</b>
Ericaceae ( <i>Erica/ Calluna</i> )	26	0	0	4	9	0	0	0	<b>39</b>	<b>3</b>
<i>Ilex aquifolium</i>	0	0	0	0	0	0	6	0	<b>6</b>	<b>1</b>
Maloideae	0	0	0	1	0	0	0	0	<b>1</b>	<b>1</b>
<i>Quercus</i> sp	0	52	6	0	5	4	18	17	<b>102</b>	<b>6</b>
<i>Quercus</i> roundwood	0	0	1	0	0	0	0	0	<b>1</b>	<b>1</b>
<i>Salix/Populus</i> sp	0	0	0	0	0	1	8	3	<b>12</b>	<b>3</b>
cf <i>Sambucus nigra</i>	0	0	0	2	0	0	0	0	<b>2</b>	<b>1</b>
Unidentified	0	4	1	3	0	0	0	0	<b>8</b>	<b>3</b>
Unidentifiable twigwood	48	0	0	11	3	0	0	0	<b>62</b>	<b>3</b>
<b>Total identified</b>	<b>76</b>	<b>72</b>	<b>12</b>	<b>35</b>	<b>39</b>	<b>100</b>	<b>100</b>	<b>100</b>	<b>534</b>	–

at 8% and willow/poplar (*Salix/Populus* sp) 8%. Holly (*Ilex aquifolium*) was also present (6%), this being absent from elsewhere at Dun Fhinn. A minimum of 16% of the total birch (*Betula pendula/pubescens*) and hazel wood in this context was juvenile roundwood, cut at 4–6 years old, measuring 10–12mm diameter.

From below C013, a sample of charcoal was analysed from the silty-deposit (C015) which had built up against the wall between the dun and the roundhouse. Charcoal was relatively abundant and taxonomically varied, with 32% birch, 28% hazel, 17% oak and a greater proportion of wetland tree types than elsewhere (23% alder (*Alnus glutinosa*) and willow/poplar). No birch roundwood was identified (possibly due to fragmentation rather than absence) but alder and hazel roundwood were common, a sample of which was selected for radiocarbon dating, SUERC-95425 (Table 1).

#### TRENCH 1, FROM WITHIN THE ROUNDHOUSE

Three samples of charcoal were analysed from stratified deposits within the roundhouse (C010, C011, C012), comprising 174 fragments. The uppermost layer in the sequence, C010, contained birch, hazel, Ericaceae twigs, possible elder (cf *Sambucus nigra*) and a single fragment of Maloideae charcoal. A sample of *Betula* was selected for radiocarbon dating, SUERC-95431. Oak was notably absent. Deposit C011 contained a modestly sized but well-preserved assemblage dominated by birch (31%), with hazel, oak, alder and 23% Ericaceae twigs. Deposit C012 was the stratigraphically earliest and most charcoal-rich layer, its assemblage containing 72% birch, 19% hazel and 4% oak. Wetland tree types were also represented in low numbers, with alder and willow/poplar identified. Several fragments were vitrified and highly reflective, suggesting the fire

may have reached a high temperature. A sample of *Betula* was selected for radiocarbon dating, SUERC-95430 (Table 1).

## TRENCH 2

A sample of charcoal was analysed from the layer of thin grey silt (C008) that partly overlay bedrock and partly a trampled layer (C009). This sample was the only context with charred remains other than wood charcoal, namely bark and two fragments of undifferentiated parenchymatous tissue. This might represent processed food such as porridge or bread. The charcoal assemblage was of only two taxa, oak (69%) and hazel (22%), plus unidentifiable pieces. The oak pieces, where discernible, were mature at >20 years old when cut. Many pieces were impregnated with minerals, unlike the rest of the site assemblage, and had therefore been exposed to a different preservational environment, possibly involving the presence of cess or debris with a high proportion of metals. The assemblage from the underlying trampled surface (C009) had only 12 fragments >2mm but was unaffected by mineral impregnation. These fragments included

birch, hazel and oak; a fragment of oak was selected for radiocarbon dating, SUERC-95426 (Table 1).

## Overview

Except for deposit C002, the archaeological evidence suggests that all the charcoal assemblages described derive from domestic activity, the wood having been used as fuel for cooking and heating. Birch is most common at 29%, occurring in six out of eight contexts, with hazel at 24% (seven out of eight contexts and 21% of which was roundwood) and oak (19%, six out of eight contexts) (Table 3). A minimum of six further wood types were also used for fuel, including holly, alder (four out of eight contexts, 6%), willow/poplar, Ericaceae, possible elder and a member of the Maloideae. The Maloideae occurred in insufficient numbers and size to identify further but may represent hawthorn, given the dominance of scrub and heathland taxa demonstrated by dominance of birch and one or more members of the Ericaceae. The relative proportions of the taxa used are depicted in Illus 27 and their ubiquities in Illus 28, indicating use of a range of trees and shrubs rather than reliance on just a single type.

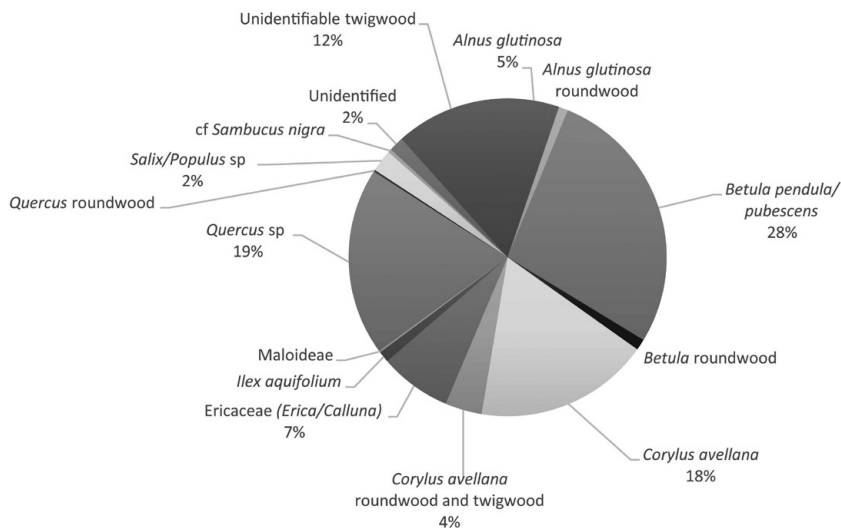

ILLUS 27 Proportions of wood types within the Dun Fhinn charcoal assemblages (n = 534). (Image by Catherine Barnett)

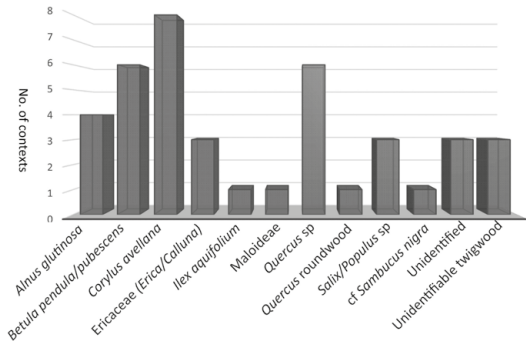

ILLUS 28 Ubiquities of wood types within Dun Fhinn charcoal assemblages. (Image by Catherine Barnett)

RADIOCARBON DATES

Five samples were selected from the wood charcoal assemblages to date contexts chosen during excavation to establish a site chronology. Radiocarbon dates were provided by SUERC and calibrated using OxCal v4 IntCal20 (Table 1, Illus 29).

SUERC-95425, SUERC-95426 and SUERC-95430 are statistically consistent ( $\chi^2$ ,  $df=2$ ,  $T=1.9$  (5% 6)); when combined ( $2384 \pm 16$   $^{14}C$  BP), they provide a calibrated date of 516–397 (95.4%).

The dates correspond to stratigraphic order (Illus 30) and indicate a minimum of three activity events, with median dates of 456.5 cal BC, 127.5 cal BC and AD 1544.5.

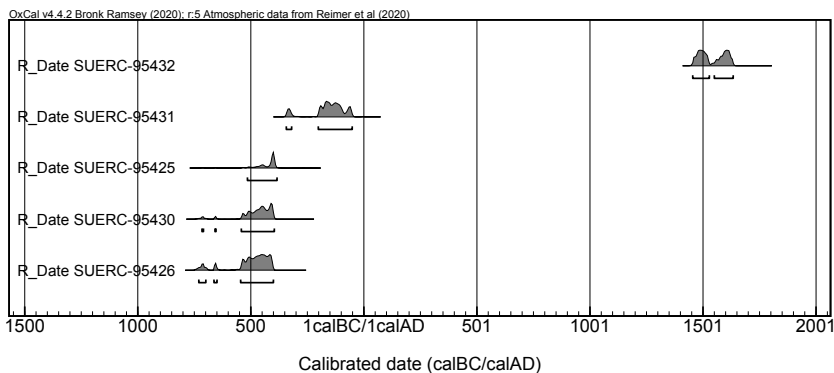

ILLUS 29 Radiocarbon dates from Dun Fhinn. (Image by Darko Maričević)

INTERPRETATION

The construction of Dun Fhinn involved building a perimeter wall around the summit of the knoll to enclose an oval-shaped area of 18m north-west/south-east and 11m wide at its maximum. The standing remains and quality of rubble below the knoll suggest this wall had been formidable in size. Whether the outworks had been constructed at the same time or were a later addition remains unknown. Within the interior of this wall, a roundhouse was constructed with an internal diameter of between 6.0 and 6.4m. It made use of a large rectangular block of bedrock for its basal course, large blocks of stone for facing-stones and smaller stones for internal packing. This construction, the 1.2m width of its wall footings, and evidence for at least four courses, suggest the roundhouse had been a substantial structure, assumed to have had a timber superstructure and either a thatched or turf roof.

The lowermost deposits within the roundhouse (C019) consist of a light grey/white clay, which might either be a natural formation or the remnants of a floor, containing a reddened and harder patch (C016) that is likely to have arisen from burning. The deposits over this clay (C011, C012), that in the space between the wall of the roundhouse and the internal face of the dun’s perimeter wall (C015), and that at the western edge of the dun (C008, C009) are interpreted as arising from occupation, with their charcoal deriving from wood used as fuel for heating and

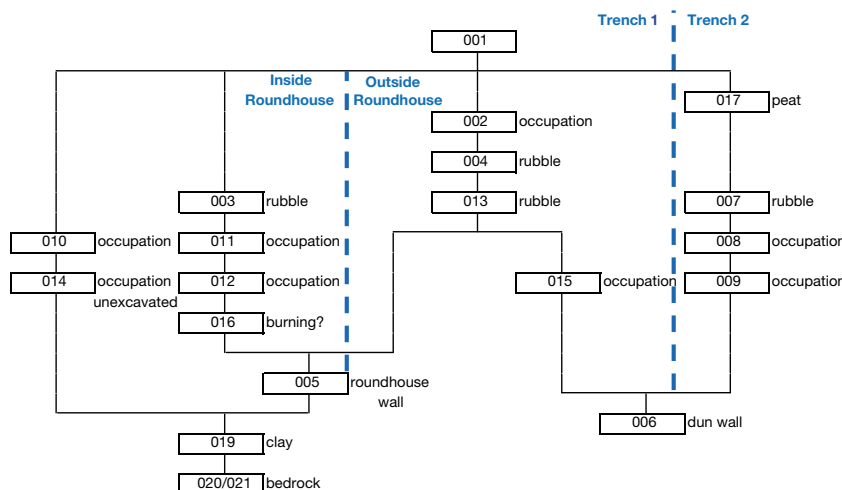

ILLUS 30 Dun Fhinn matrix. (Image by Roddy Regan)

cooking. The charcoal assemblages are similar, with a dominance of birch, strong representation of hazel and oak, and wetland tree species including alder and willow/poplar. Radiocarbon dates for these deposits were consistent, indicating activity between 516 and 397 BC. This provides a *terminus ante quem* for the construction of the dun. Such occupation appears to have taken place on rough, cobbled surfaces (C005, C009, C014).

The artefacts from these horizons, two utilised pebbles (SF2, SF3), fragments of fired clay (SF1) and a rim fragment of a wooden bowl (SF4), provide little indication of activities. While the fired clay may be fragments of very coarse pottery, they are more likely to represent fired daub from a heat-affected structure. Vitrified fragments of charcoal suggest that high temperatures were sometimes attained. Some internal variation in activities might be represented by the condition of the charcoal at the far west end of dun's interior (Trench 2). That within deposit C008 was impregnated with minerals, suggesting a different depositional environment from elsewhere, and contained only hazel and oak, the latter deriving from mature trees potentially used for roof and wall construction. This deposit also contained bark and parenchyma that might derive from porridge or bread; the absence of charred cereal grains from any of the deposits is notable.

Overall, the scarcity of finds and shallowness of these occupation deposits suggest that activity had been brief. This might, however, reflect erosion of deposits or simply the limited extent of excavation, with more substantial traces of occupation existing elsewhere at the site. Indeed, brief and sporadic periods of activity appear anomalous with the considerable effort used to construct the dun and roundhouse.

The mid-1st millennium cal BC occupation was followed by a collapse of the roundhouse wall, some of this falling inwards (C003). The rubble deposit (C013) external to the roundhouse might also derive from the collapse of its walls; alternatively, it might simply be a dump of stones. There was a second 1st-millennium cal BC occupation at the dun, represented by a deposit (C010) containing similar wood types, except for oak. This is dated to between 202 and 53 cal BC (87.1%). Whether this preceded or followed the collapse of the roundhouse wall could not be determined because of the limited spatial extent of the excavation.

Given the high proportion of scrub and heath/moorland types in the fuel assemblages (Ericaceae, birch and possible hawthorn), it is likely that 1st-millennium cal BC woodland in vicinity of Dun Fhinn was rather patchy and potentially under pressure from local populations

for fuel. What remained of the native oak-hazel-holly woodlands was apparently relatively open, given the high proportion of hazel and lack of other large tree types such as ash and elm. Wetland habitats were also exploited, with alder and willow/poplar together forming 10% of the total site assemblage.

The high proportion of roundwood in deposits C013 and C015 is notable. Their presence, and same-age profile (cut at 4–6 years, 10–12mm diameter where discernible), hints at the use of a woodland management regime for birch, alder and hazel. Since all the wood would have had to be carried up the steep slopes of the site, additional travel to collect distant sources of wood is highly unlikely and any such managed woodland is inferred to have been local to the site.

The uppermost rubble layer (C004 and C017) contained voids, giving the impression of being rapidly formed and most likely representing the collapse or deliberate demolition of the dun's perimeter wall. Its surface gave the impression of a trampled layer, and the date of AD 1455–1634 from overlying silt (C002) suggests a short period of later medieval activity. This deposit included hazel twigwood and heather that had been twisted together prior to charring, suggesting the possibility of a roofed shelter constructed within the remains of the dun. This activity is open to various interpretations, including the quarrying and robbing of stone from the site or even the dun being used as a shelter during clan conflict. These and other interpretations remain speculative in the absence of further evidence.

## DISCUSSION

### IRON AGE CHRONOLOGY AND SETTLEMENT PATTERNS IN ARGYLL

The radiocarbon dates from Dun Fhinn contribute to an emerging picture within Argyll of duns being constructed in the latter half of the 1st millennium BC. Dun Fhinn has produced the earliest dates for such structures, falling in the late 6th or 5th century BC (Illus 31). The dates for Dun Fhinn are encompassed within the chronology recently

secured for Loch nan Deala crannog on Islay (Illus 3) that underwent a sequence of structural rearrangements (Maričević et al 2020). These started between the 8th and the 6th century BC, continued with secondary occupation in the 4th–3rd centuries BC, with probable abandonment in the 2nd–1st century BC (Illus 31), although the precise morphology of structures on this site remains to be firmly established.

Islet settlement at Loch Allalaidh, consisting of a substantial oval outer wall and a smaller circular structure inside it, provides the closest parallel to Dun Fhinn as far as the size and the spatial arrangement of structures are concerned (Illus 32). The structural sequence at Barnluasgan in North Knapdale, where a roundhouse supersedes an irregular or sub-rectangular dun, demonstrates that not all such arrangements were contemporary (Regan & Campbell 2022), nor is the shape of the works a reliable dating parameter (Illus 32).

Dun Fhinn's internal circular structure was constructed at an early stage in its occupation, probably being integral to its original layout. The width of its wall and its diameter are similar to those of hut-circles found on Islay, notably those located 400m south-west of Dun Fhinn (Canmore ID 38092). While traditionally attributed to the Bronze Age, such hut-circles are being identified as part of the Iron Age settlement pattern on Skye (Welti & Wildgoose nd, Wildgoose 2016), while Iron Age activity has been documented at the otherwise Bronze Age hut-circles and field system of An Sithean on Islay (Barber & Brown 1984).

When the area of excavation and depth of surviving deposits is considered, the sparse number of artefacts within Dun Fhinn is comparable to that at the other 1st-millennium cal BC duns. Whether this reflects a genuine aceramic culture or the character of occupation and activities remains unclear. At present, all we can infer is the use of a range of wood types as fuel, the possible use of oak and clay for construction, the use of a small wooden bowl, and the use of unmodified pebbles as hammerstones and for tasks involving rubbing. At face value, the occupation deposits at Dun Fhinn are surprisingly meagre when

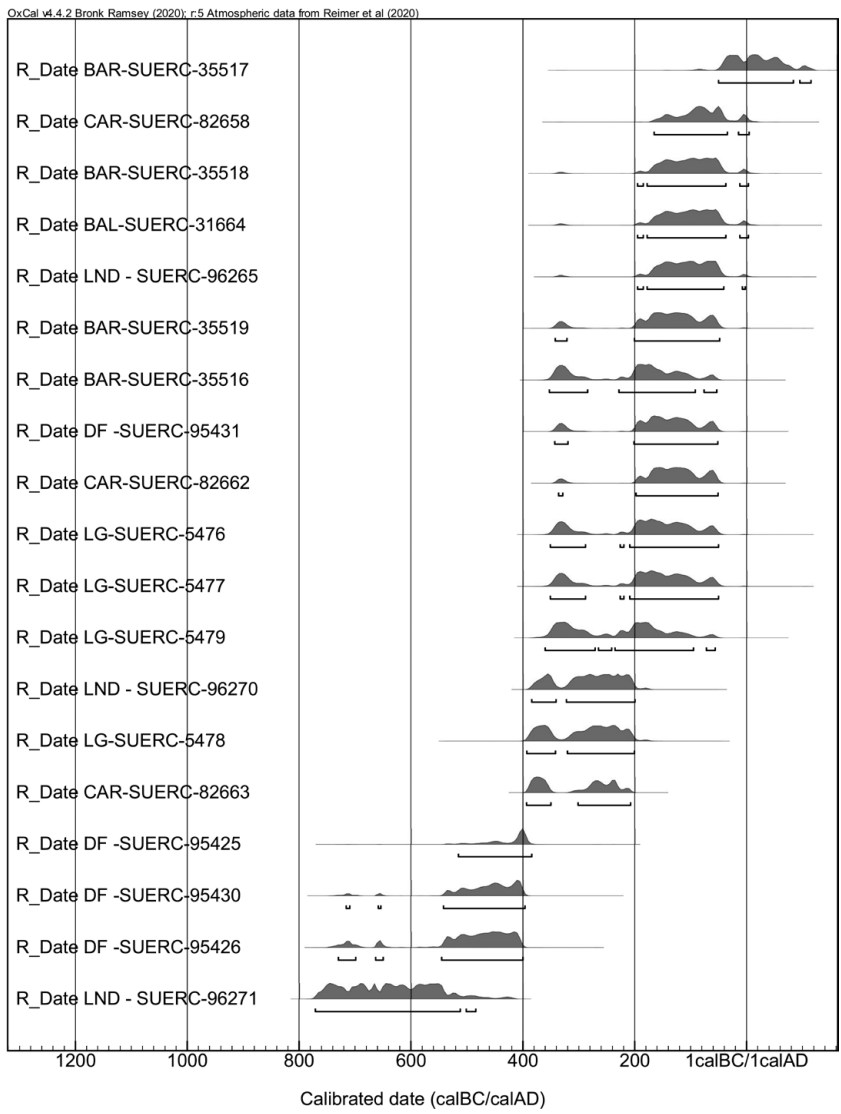

ILLUS 31 Radiocarbon dates from Dun Fhinn (DF), Loch nan Deala (LND), Carnassarie (CAR), Balure (BAL), Barnluasgan (BAR) and Loch Glashan (LG). (Image by Darko Maričević)

compared to the substance of the architecture. Whether this is primarily a reflection of the small scale of excavation and erosion history of the site or is an accurate reflection of sporadic and brief periods of occupation remains unclear.

If the latter, we must ask where the Iron Age people were primarily resident. Is there a largely undiscovered element of Iron Age settlement

consisting of small wood and turf-built dwellings that would supplement the possible use of hut-circles normally attributed entirely to the Bronze Age? Traces of such settlement on Islay are gradually emerging (Illus 3), including hearths and traces of cultivation at Ardnave dating to between 700 and 300 BC (Ritchie & Welfare 1983), a small dwelling at Kilchoman

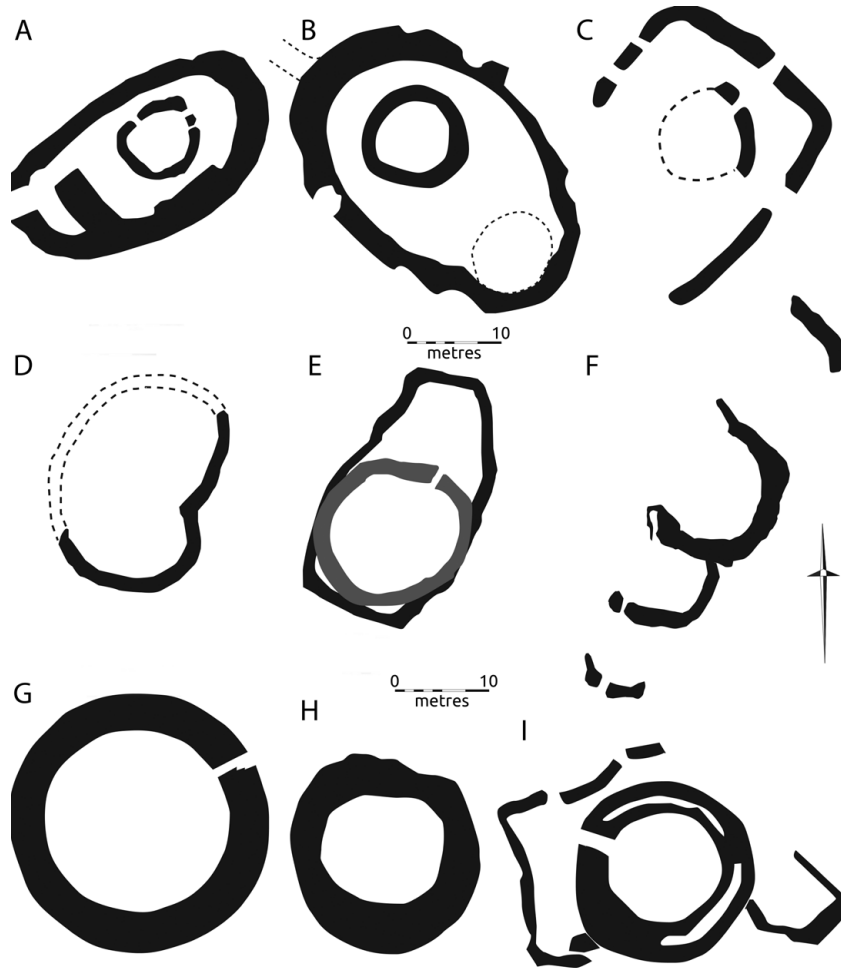

ILLUS 32 Simplified plans of duns and allied structures in Argyll: A – Dun Fhinn, Islay; B – Loch Allalaidh, Islay; C – Creagan na Ceardaich Moire, Islay; D – Carnasserie, Mid Argyll; E – Barnluasgan, Knapdale; F – Balure, Knapdale; G – Loch Glashan, Mid Argyll; H – Rahoy, Morvern; I – Dun Chroisprig, Islay. (Image by Darko Maričević; B, C, and I after RCAHMS 1984; D after Regan 2017; E and F after Regan and Campbell 2022; G after Henderson and Gilmour 2011; H after RCAHMS 1980)

dating to 895–802 BC (Ellis 2015), and at Coultorsay with evidence for both ironworking and domestic activity. Although undated, a rotary quern, shale bracelet and possible Iron Age pottery suggest the Late Iron Age (Kilpatrick 2016). Souterrains have been found at Druim a' Chuirn (Caldwell & Ruckley 2007) and also at Kilellan, where remains of a dry-stone roundhouse and activity dated to both the Early (820–410 BC) and the Middle Iron Age (200 BC – AD 220) were also identified (Ritchie 2005).

#### THE EMERGENCE OF THE DRY-STONE MONUMENTAL ARCHITECTURAL TRADITION IN ARGYLL

The emerging picture of a growing number of Atlantic roundhouses, duns and crannogs within Argyll dating to the 1st millennium BC challenges the notion that these structures had developed during a time of conflict associated with the formation of the Dál Riata kingdom in the 1st millennium AD. What might have been the



motivation to construct these broadly contemporary yet diverse dry-stone structures? With their thick walls and often defensive locations it is difficult to avoid invoking periods of conflict, whether these were localised or regional involving population displacements.

One possible cause of conflict is competition for land and woodland arising from climate change. Climatic instability involving periods of intense storminess in 920–780, 740–560 and 480–380 BC has recently been demonstrated for south Islay (Kylander et al 2019). This is consistent with the high proportion of scrub and heath/moorland types in the fuel assemblage from Dun Fhinn, suggesting its surrounding woodland was rather patchy. What remained of the oak-hazel-holly woodlands was apparently relatively open, given the high proportion of hazel and lack of other large tree types such as ash and elm. Pollen records from elsewhere on Islay show decline in tree pollen from the Middle Bronze Age onwards (Edwards & Berridge 1994). Wetland habitats are also evident, with alder and willow/poplar together forming 10% of the total site assemblage.

Such climate change, resulting pressure on cultivatable land and woodland, and emerging conflict at either a local or regional scale, might have encouraged a shift from the relatively open and accessible Bronze Age settlement represented by hut-circles to that of duns and forts during the 1st millennium BC. In this scenario the circular structure inside Dun Fhinn would represent the shift of a common Bronze Age architectural form, the hut-circle, into the increasingly monumental, defended and conspicuously placed structures that dominate the Iron Age settlement pattern. We note that others have attempted to make the case for the possible origins of the Atlantic roundhouse tradition among the hut-circles via a gradual increase in wall size (Romankiewicz 2009).

If climate change played a role in settlement change of the 1st millennium BC, we suspect it would have been just one of several factors operating at a local, regional and continental scale that led to a fundamental change in settlement pattern and architecture as seen on Islay and throughout Argyll. One indication of a matrix

of factors operating at local and regional scales is the variety of architectural choices that were employed during the second half of the 1st millennium BC in Argyll (Illus 32). It is too early to say whether such choices were driven by practical concerns, such as making the most of the building locations by utilising the topography of the knolls and promontories, or whether they represent distinct architectural traditions, which either converged or simultaneously developed in Argyll.

## CONCLUSION

Any consideration of why and how settlement patterns changed will remain speculative until further steps are completed in building an Iron Age chronology for Argyll. Fortunately, the work at Dun Fhinn, Loch nan Deala and Loch Glashan has demonstrated that small-scale fieldwork can provide reliable dating evidence and hence provides the prospect for a cost-effective wide-scale sampling of duns, forts and crannogs on Islay and throughout Argyll to establish a robust chronology.

**Supplementary material:** Appendix 1 available online at <https://doi.org/10.9750/PSAS.151.1329>

## ACKNOWLEDGEMENTS

The project would like to thank the Ian Mactaggart Third Fund for funding the excavation and survey work via a donation to Islay Heritage (SC046938), and the Society of Antiquaries of Scotland for funding the radiocarbon dating. The fieldwork was made possible by Scheduled Monument Consent from Historic Environment Scotland (HES ref: AMH/4016/1, Case ID: 300024930). We are grateful to the Ardtalla Estate for permission to excavate and for its support, notably from Tom Dunn, who provided insights into the area's history and generously helped transport our gear to the site. For working in challenging conditions caused by the 'beast from the east' of April 2018, our thanks

go to Nick Pankhurst, Kerry Davene Baker, Guy Cockin and Lauren Hale. Also to Dr Rob Fry for undertaking the contour survey, Professor Martin Bell for describing SF4, identifying it as the carbonised rim fragment from a wooden bowl, and to Sarah Lambert-Gates for preparing its illustration.

## REFERENCES

- Alcock, L & Alcock, E 1987 'Reconnaissance excavations on the Early Historic Fortifications and other Royal sites in Scotland, 1974–84: 2, Excavations at Dunollie Castle, Oban, Argyll, 1987', *Proc Soc Antiq Scotland* 117: 119–47.
- Ashbee, P, Bell, M & Proudfoot, E 1989 *Wilsford Shaft: Excavations 1960–62*. London: English Heritage.
- Ashmore, P J 1997 'Radiocarbon Dates from Archaeological Sites in Argyll and Arran', in Ritchie, G (ed) *The Archaeology of Argyll*, 236–83. Edinburgh: RCAHMS and Edinburgh University Press.
- Armit, I 1991 'The Atlantic Scottish Iron Age: five levels of chronology', *Proc Soc Antiq Scotland* 121: 181–214.
- Armit, I 1992 *The Later Prehistory of the Western Isles of Scotland*. Oxford: British Archaeological Reports, British Series, 221.
- Armit, I 2004 'The Iron Age', in Omand, D (ed) *The Argyll Book*, 46–59. Edinburgh: Birlinn.
- Asouti, E & Austin, P 2005 'Reconstructing woodland vegetation and its relation to human societies, based on the analysis and interpretation of archaeological wood charcoal macro-remains', *Environmental Archaeology* 10: 1–18.
- Barber, J & Brown, M 1984 'An Sithean, Islay', *Proc Soc Antiq Scotland* 114: 161–88.
- Bronk Ramsey, C 2020 *OxCal v. 4.4*. <https://c14.arch.ox.ac.uk/oxcal/OxCal.html>. Accessed 7 July 2021.
- Butterfield, B G & Meylan, B A 1980 *Three-Dimensional Structure of Wood: An Ultrastructural Approach*. London/New York: Chapman and Hall.
- Caldwell, D H 2010 'Finlaggan report 7 – Eilean na Comhairle', unpublished interim report, National Museums Scotland, Edinburgh.
- Caldwell, D H & Ewart, G 1993 'Finlaggan and the Lordship of the Isles: an archaeological approach', *Scottish Historical Review* 72: 146–66.
- Caldwell, D H & Ruckley, N A 2007 'Druim a' Chuirn, Carnbeg, Argyll and Bute (Killarow and Kilmeny parish), settlement with souterrain', *Discovery and Excavation in Scotland*, new series 2007 vol 8: 40–1.
- Cavers, G 2010 *Crannogs and Later Prehistoric Settlement in Western Scotland*. Oxford: British Archaeological Reports, British Series, 510.
- Cavers, G & Crone, A 2019 'Black Loch of Myrton, Excavation', *Discovery and Excavation in Scotland*, new series 2018 vol 19: 60–1.
- Cavers, G & Crone, A 2020 'Black Loch of Myrton, Excavation', *Discovery and Excavation in Scotland*, new series 2019 vol 20: 53.
- Chabal, L 1992 'La représentativité paléocéologique des charbons de bois archéologiques issus du bois de feu', in Vernet, J L (ed) *Les charbons de bois, les anciens écosystèmes et le rôle de l'Homme*. *Bulletin de la Société Botanique de France* 139(2, 3, 4): 213–36.
- Chabal, L 1997 *Forêts et sociétés en Languedoc (Néolithique Final, Antiquité Tardive). L'anthracologie, méthode et paléocéologie*, Documents d'archéologie française 63. Paris: Éditions de la Maison des sciences de l'homme.
- Childe, V G 1934 'Notes on some duns on Islay', *Proc Soc Antiq Scot* 69: 81–4.
- Dixon, T N 1981 'Preliminary excavation of Oakbank crannog, Loch Tay: interim report', *International Journal of Nautical Archaeology Underwater Explorer* 10: 15–21.
- Earl, P 1980 *Tales of Islay: Fact and Folklore*. Bowmore: Celtic House.
- Earwood, C 1998 'Typology of Bronze Age wooden containers: new dating evidence from Islay', *Proc Soc Antiq Scot* 128: 161–6.

- Edwards, K J & Berridge, J A 1994 'The Late-Quaternary vegetation history of Loch a' Bhogaidh, Rinns of Islay SSSI, Scotland' *New Phytologist* 128: 749–69.
- Ellenberg, H 1988 *Vegetation Ecology of Central Europe*, 4th edition. Cambridge: Cambridge University Press.
- Ellis, C 2015 *Final Report: The Archaeology at Shepherd's Cottage, Kilchoman, Islay*. Argyll Archaeology Report no. 189.
- Framework Archaeology 2010 *Landscape Evolution in the Middle Thames: Heathrow Terminal 5 Excavations*, vol 2. Framework Archaeology, Har/Cdr edition.
- Gale, R & Cutler, D 2000 *Plants in Archaeology*. West Yorkshire and Kew: Westbury and Royal Botanic Gardens.
- Gilmour, S 2000 'Later Prehistoric and Early Historic Settlement Archaeology of the Western Seaways: A Study of the Western Settlement Record from Shetland to Brittany in the first Millennium BC and AD', unpublished PhD thesis, University of Edinburgh.
- Harding, D W 1984 'The function and classification of brochs and duns', in Miket, R & Burgess, C (eds) *Between and Beyond the Walls: Essays on the Prehistory and History of North Britain in Honour of George Jobey*, 206–20. Edinburgh: John Donald.
- Harding, D W 1997 'Forts, duns, brochs and crannogs: Iron Age settlements in Argyll', in Ritchie, G (ed) *The Archaeology of Argyll*, 116–40. Edinburgh: Edinburgh University Press.
- Harrington, P & Pierpoint, S 1980 'Port Charlotte chambered cairn, Islay: an interim note', *Glasgow Archaeological Journal* 7: 113–15.
- Henderson, J & Gilmour, S 2011 'A 1st millennium BC Atlantic roundhouse in Argyll: survey and excavation at Loch Glashan', *Proc Soc Antiq Scot*, 141: 75–102.
- Keepax, C A 1988 'Charcoal Analysis, with Special Reference to Archaeological Sites', unpublished PhD thesis, University of London.
- Kilpatrick, M S 2016 *Coultorsay, Islay: Archaeological Evaluation, Monitored Topsoil Strip and Excavation Data Structure Report Project 4188*. Guard Archaeology.
- Kylander, M E, Söderlindh, J, Schenk, F, Gyllencreutz, R, Rydberg, J, Martinez Cortizas, A & Skelton, A 2019 'It's in your glass: a history of sea level and storminess from the Laphroaig bog, Islay (south western Scotland)', *Boreas* 49: 152–67.
- Lane, A M & Campbell, E 2000 *Dunadd: An Early Dalriadic Capital*. Cardiff Studies in Archaeology Specialist Report, vol 19. Cardiff: Cardiff School of History and Archaeology. Oxford: Oxbow Books.
- Leney, L & Casteel, R W 1975 'Simplified procedure for examining charcoal specimens for identification', *Journal of Archaeological Science* 2: 153–9.
- MacKie, E W 1974 *Dun Mor Vaul: An Iron Age Broch on Tiree*. Glasgow.
- MacKie, E 1976 'Cultoos, Islay', *Glasgow Archaeological Society Bulletin* 2.
- MacKie, E W 1997 'Dun Mor Vaul revisited: fact and theory in the reappraisal of the Scottish Atlantic Iron Age', in Ritchie, G (ed) *The Archaeology of Argyll*, 141–80. Edinburgh: RCAHMS and Edinburgh University Press.
- McParland, L C, Collinson, M E, Scott, A C, Campbell, G & Veal, R 2010 'Is vitrification in charcoal a result of high temperature burning of wood?' *Journal of Archaeological Science* 37: 2679–87.
- Maričević, D, Batchelor, R & MacLeod, A 2020 'Loch nan Deala Crannog, Islay', *Discovery and Excavation in Scotland*, new series 2019 vol 20: 42.
- Mithen, S J 2000 *Hunter-Gatherer Landscape Archaeology: The Southern Hebrides Mesolithic Project*. Cambridge: MacDonal Institute.
- Mithen, S J, Wicks, K, Pirie, A E, Riede, F, Lane, C, Banjerea, R, Cullen, V, Gittins, M & Pankhurst, N 2015 'A late glacial archaeological site and tephra sequence in the far northwest of Europe: Ahrensburgian artefacts and geoarchaeology at Rupha Port an t-Seilich, Isle of Islay, western Scotland', *Journal of Quaternary Science* 30: 396–416. doi: 10.1002/jqs.2781.
- Mithen, S J, Maričević, D & Regan, R 2020 'The seal matrix of Sir John Campbell and the

- struggle for Dunyvaig Castle on the Isle of Islay', *Antiquity* 94(374): 1–8.
- Munro, R et al 1879 'Notice of the excavation of a crannog at Lochlee, Tarbolton, Ayrshire', *Proc Soc Antiq Scot* 13: 177–241.
- Must Farm 2016 'Dig Diary 25: Wooden Objects'. <http://www.mustfarm.com/progress/site-diary-25-wooden-objects/>. Accessed 8 July 2021.
- Newall, F 1963 'Crannog site? Garryeallabus', *Discovery and Excavation Scotland* 1963: 18–19.
- Nieke, M 1983 'Settlement patterns in the first millennium AD: a case study of the Island of Islay', in Chapman, J C & Mytum, H C (eds) *Settlement in Northern Britain 1000 BC – AD 1000*, 299–325. Oxford: British Archaeology Reports, British Series, 118.
- Nieke, M R 1990 'Fortifications in Argyll: retrospect and future prospect', in Armit, I (ed) *Beyond the Brochs: Changing Perspectives on the Atlantic Scottish Iron Age*, 131–42. Edinburgh: Edinburgh University Press.
- Nieke, M R 2004 'Secular society from the Iron Age to Dál Riata and the Kingdom of the Scots', in Omand, D (ed) *The Argyll Book*, 60–70. Edinburgh: Birlinn.
- Nieke, M R & Boyd, W E 1987 'Eilean an Duin, Craignish, mid Argyll', *Glasgow Archaeological Journal* 14: 48–57.
- Peltenburg, E J 1982 'Excavations at Balloch Hill, Argyll', *Proc Soc Antiq Scot* 112: 142–214.
- Peterken, G 1993 *Woodland Conservation and Management*, 2nd edition. London: Chapman and Hall.
- Prior, J & Alvin, K L 1983 'Structural changes on charring woods of *Dictostachys* and *Salix* from Southern Africa', *International Association of Wood Anatomists Bulletin* 4: 197–206.
- RCAHMS 1971 *The Royal Commission on the Ancient and Historical Monuments of Scotland. Argyll: An Inventory of the Ancient Monuments*, vol 1: *Kintyre*. Edinburgh.
- RCAHMS 1980 *The Royal Commission on the Ancient and Historical Monuments of Scotland. Argyll: An Inventory of the Ancient Monuments*, vol 3: *Mull, Tiree, Coll and northern Argyll*. Edinburgh.
- RCAHMS 1984 *The Royal Commission on the Ancient and Historical Monuments of Scotland. Argyll: An Inventory of the Ancient Monuments*, vol 5: *Islay, Jura, Colonsay and Oronsay*. Edinburgh.
- Regan, R 2008 *Balure Dun, Dalriada Project, Excavation Data Structure Report*. Kilmartin Museum Report no. 20.
- Regan, R 2017 *Carnassarie Castle, Argyll. Beyond the Bishop, a Community Excavation, Data Structure Report 2017*. Kilmartin Museum.
- Regan, R & Campbell, E 2022 'Barnluasgan and Balure: the excavation of two Iron Age duns in North Knapdale, Argyll', *Scottish Archaeological Internet Reports* 99. <https://doi.org/10.9750/issn.2056-7421.2022.99>
- Reimer, P, Austin, W, Bard, E, Bayliss, A, Blackwell, P, Bronk Ramsey, C et al 2020 'The IntCal20 Northern Hemisphere radiocarbon age calibration curve (0–55 cal kBP)', *Radiocarbon*, 62(4): 725–57. doi:10.1017/RDC.2020.41.
- Richter, H G, Grosser, D, Heinz, I & Gasson, P E (eds) 2004 'IAWA list of microscopic features for softwood identification', *IAWA Journal* 25: 1–70.
- Ritchie, A 2005 *Kilellan Farm, Ardnave, Islay*. Edinburgh: Society of Antiquaries of Scotland.
- Ritchie, J N G 1970 'Iron Age finds from Dun an Fheurain, Gallanach, Argyll', *Proc Soc Antiq Scot* 103: 100–12.
- Ritchie, J N G & Harman, M 1985 *Exploring Scotland's Heritage: Argyll and the Western Isles*. Edinburgh: The Royal Commission on the Ancient and Historical Monuments of Scotland.
- Ritchie, J N G & Lane, A M 1980 'Dun Cul Bhuirg, Iona, Argyll', *Proc Soc Antiq Scot* 110: 209–29.
- Ritchie, J N G & Welfare, H 1983 'Excavations at Ardnave, Islay', *Proc Soc Antiq Scot* 13: 302–66.
- Romankiewicz, T 2009 'Simple stones but complex constructions: analysis of architectural developments in the Scottish Iron Age', *World Archaeology*, 41(3): 379–95.
- ScARF 2012 Hunter, F & Carruthers, M (eds) *Iron Age Scotland Panel Report*. Scottish Archaeological Research Framework: Society of Antiquaries of Scotland. <https://tinyurl.com/vpla6yxr>. Accessed 3 February 2022.

- ScARF 2017 Regan, R (ed) *RARFA: The Regional Archaeological Research Framework for Argyll, 7. The Iron Age: 700 BC – AD 500*. Society of Antiquaries of Scotland. <https://scarf.scot/regional/rarfa/the-iron-age-700-bc-ad-500>. Accessed 3 February 2022.
- Schweingruber, F H 1990 *Microscopic Wood Anatomy*, 3rd edition. Birmensdorf: Swiss Federal Institute for Forest, Snow and Landscape Research.
- Shackleton, C & Prins, F 1992 ‘Charcoal analysis and the “Principle of least effort”: A conceptual model’, *Journal of Archaeological Science* 19: 631–7.
- Stace, C 2010 *New Flora of the British Isles*, 3rd edition. Cambridge: Cambridge University Press.
- Stevenson, J B 1984 ‘The excavation of a hut-circle at Cul a’ Bhaile, Jura’, *Proc Soc Antiq Scot* 114: 127–60.
- Théry-Parisot, I, Chabal, L & Chravzez, J 2010 ‘Anthracology and taphonomy, from wood gathering to charcoal analysis: A review of the taphonomic processes modifying charcoal assemblages, in archaeological contexts’, *Palaeogeography, Palaeoclimatology, Palaeoecology* 291: 142–53.
- Walti, A & Wildgoose, M nd ‘Wedigs Project 2012–2014. Final Report. A Study of West Coast Circular Structures through Landscape Survey, Site Survey and Excavation. A Community Archaeological Project’, unpublished report. [https://her.highland.gov.uk/api/LibraryLinkWebServiceProxy/FetchResource/303802/full\\_303802.pdf](https://her.highland.gov.uk/api/LibraryLinkWebServiceProxy/FetchResource/303802/full_303802.pdf). Accessed 4 February 2022.
- Wildgoose, M 2016 ‘Uamh an Ard Achadh (High Pasture Cave) and Environs Project: Data Structure Report. Landscape Survey 2006–2010’, unpublished report. [https://highland.esdm.co.uk/api/LibraryLinkWebServiceProxy/FetchResource/308737/full\\_308737.pdf](https://highland.esdm.co.uk/api/LibraryLinkWebServiceProxy/FetchResource/308737/full_308737.pdf). Accessed 4 February 2022.

*The online version of this paper is available in open access under the terms of the Creative Commons Attribution-NonCommercial 4.0 International licence (CC-BY-NC 4.0) <https://creativecommons.org/licenses/by-nc/4.0>*