

Beyond PEGylation: alternative surface-modification of nanoparticles with mucus-inert biomaterials

Article

Accepted Version

Creative Commons: Attribution-Noncommercial-No Derivative Works 4.0

Khutoryanskiy, V. V. ORCID: <https://orcid.org/0000-0002-7221-2630> (2018) Beyond PEGylation: alternative surface-modification of nanoparticles with mucus-inert biomaterials. *Advanced Drug Delivery Reviews*, 124. pp. 140-149. ISSN 0169-409X doi: <https://doi.org/10.1016/j.addr.2017.07.015> Available at <https://centaur.reading.ac.uk/71722/>

It is advisable to refer to the publisher's version if you intend to cite from the work. See [Guidance on citing](#).

Published version at: <http://www.sciencedirect.com/science/article/pii/S0169409X17301229>

To link to this article DOI: <http://dx.doi.org/10.1016/j.addr.2017.07.015>

Publisher: Elsevier

All outputs in CentAUR are protected by Intellectual Property Rights law, including copyright law. Copyright and IPR is retained by the creators or other copyright holders. Terms and conditions for use of this material are defined in the [End User Agreement](#).

www.reading.ac.uk/centaur

CentAUR

Central Archive at the University of Reading

Reading's research outputs online

Beyond PEGylation: alternative surface-modification of nanoparticles with mucus-inert biomaterials

Vitaliy V. Khutoryanskiy

Reading School of Pharmacy, University of Reading, Whiteknights, PO Box 224, RG6 6AD
Reading, United Kingdom. E-mail: v.khutoryanskiy@reading.ac.uk

Abstract

Mucus is a highly hydrated viscoelastic gel present on various moist surfaces in our body including the eyes, nasal cavity, mouth, gastrointestinal, respiratory and reproductive tracts. It serves as a very efficient barrier that prevents harmful particles, viruses and bacteria from entering the human body. However, the protective function of the mucus also hampers the diffusion of drugs and nanomedicines, which dramatically reduces their efficiency. Functionalisation of nanoparticles with low molecular weight poly(ethylene glycol) (PEGylation) is one of the strategies to enhance their penetration through mucus. Recently a number of other polymers were explored as alternatives to PEGylation. These alternatives include poly(2-alkyl-2-oxazolines), polysarcosine, poly(vinyl alcohol), other hydroxyl-containing non-ionic water-soluble polymers, zwitterionic polymers (polybetains) and mucolytic enzymes. This review discusses the studies reporting the use of these polymers or potential application to facilitate mucus permeation of nanoparticles.

Keywords: mucus, mucoadhesion, mucus-penetrating nanoparticles; stealth polymers; poly(2-alkyl-2-oxazolines); zwitterionic polymers

1. Introduction

Drug delivery via mucosal routes offers numerous advantages, including improved drug bioavailability, ease of administration and possibility for quick therapy termination [1-11]. Transmucosal delivery is less invasive compared to injections that often helps to improve patient compliance. Mucosal routes of drug administration currently used include ocular,

nasal, oromucosal, pulmonary, gastrointestinal, vaginal, rectal and intravesical. Some of these routes offer a possibility of targeting particular organs. For example, topical administration to the eye allows targeting some intraocular tissues [12, 13]; nasal administration provides a direct access to central nervous system [14, 15]; and intravesical administration gives a possibility to reach the urinary bladder [16, 17].

Mucosal membranes covering the moist surfaces in the human body have numerous roles and functions, including protection of cellular epithelia from chemical and mechanical damage. They also provide lubrication and regulate moisture content in the underlying tissues, and prevent penetration of various environmental particles, viruses and bacteria [1, 2, 7]. In the stomach the mucus gel plays an important role in protecting epithelium from acid self-digestion [18] and also facilitates the transport of undigested boluses of food by its lubrication. In the intestinal tract the mucus gel serves as a medium for colonisation by “healthy” bacteria such as probiotics while acting as a barrier for pathogenic bacteria [19]. In the female reproductive tract the cervicovaginal mucin secretions limit the mobility of sperm outside the ovulatory phase but before ovulation the mucus becomes thinner and more permeable [20].

Mucus gel layer covering the surfaces of mucosal membranes is a dynamic system that is continuously reformed through secretion of mucins by the goblet cells. The life-time of mucus gel layer is typically very short and varies in different parts of human body. For example, in the eye it is around 5.0-7.7 min; in the respiratory tract it is 10-20 min and in the gastrointestinal tract it is 4-6 hours [21]. The protective function of the mucus also hampers the diffusion of drugs and nanomedicines, which dramatically reduces their efficiency [22, 23].

The ability of different materials, such as some polymers, to adhere and retain on the surface of mucosal membranes has been often utilised in transmucosal delivery to improve drug bioavailability [1, 2, 24]. Examples of successful commercial applications of mucoadhesive formulations include Buccastem buccal tablets (Reckitt Benckiser) for the treatment of nausea and vomiting, AzaSite® ophthalmic solution (InSite Vision) for the treatment of bacterial conjunctivitis; Sinol-M (Sinol USA Inc) spray for the relief of nasal allergies; and NyQuil® cough relief syrup (Procter & Gamble). However, despite the numerous advances in the area of transmucosal drug delivery, there a number of factors that limit further developments and efficiency of novel systems. The short life-time and fast clearance of

mucus does not allow many dosage forms to retain on mucosal surfaces to provide sustained drug delivery and the sticky and viscoelastic nature of mucus prevents drug molecules and especially nano-carriers from reaching the epithelial cells.

The development of systems facilitating the efficient diffusion of active ingredients through the mucus is important in drug delivery to the airways [25]. The efficient diffusion of drug and gene delivery systems through the mucus in the airways may lead to the breakthrough in the treatment of cystic fibrosis, one of the life-threatening inherited conditions, that causes the body to produce excessive quantities of thick mucus that blocks the lungs, affects the digestive tract and some other organs or functions [26, 27]. The development of nanomedicines capable of “slipping” through the mucus will also be of immense benefit for the treatment of patients suffering from various forms of nasal disorders such as excessive mucus secretion, congestion and obstruction caused by allergic rhinitis. Another relevant therapeutic area is the drug delivery to the vagina, where there is an urgent need in the development of novel and efficient microbicides that are promising for preventing transmission of HIV and other sexually transmitted pathogens [20]. Vaginal microbicides with excellent diffusive characteristics are expected to demonstrate significantly higher efficiency [28]. Efficient mucus penetration is also beneficial for drug delivery in the gastrointestinal tract, for example, for potential eradication of *helicobacter pylori* infections [29].

A major breakthrough in the enhancement of diffusivity of nanomaterials through mucus has been reported by the group of Hanes [30-34]. In a series of studies they demonstrated that 220 nm carboxylated polystyrene nanoparticles, that exhibit poor ability to diffuse in mucus, can be functionalised with low molecular weight poly(ethyleneglycol) (PEG), which efficiently enhances their penetration ability. The PEGylated nanoparticles have hydrophilic and near neutrally-charged surfaces that reduce mucoadhesion by preventing hydrophobic or electrostatic interactions, which mimics the ability of pathogenic microorganisms to slip through mucus. Additionally, depending on the molecular weight (Mw) of PEG, the nanoparticles can be made mucus-penetrating (when Mw is 2,000 Da) or mucoadhesive (when Mw is 10,000 Da) [30]. More recently, Hanes et al [35] also demonstrated that densely-grafted PEG of 10-40 kDa can also enhance nanoparticle diffusion through human cervicovaginal mucus ex vivo and through mouse colorectal and vaginal epithelium in vivo. Many other studies demonstrated the use of PEGylation to enhance mucus and other tissue

penetration to facilitate drug delivery to the lung [36], the gastrointestinal tract [37, 38] and the eye [39-41].

Figure 1 illustrates the concept of enhanced penetration of nanoparticles coated with inert polymers such as low molecular weight PEG or potentially any other non-mucoadhesive macromolecules. The mucoadhesive particles will typically stick to the components of mucus gel and will show lower potential for penetration, whereas non-mucoadhesive particles coated with inert polymers will be able to efficiently move through this barrier.

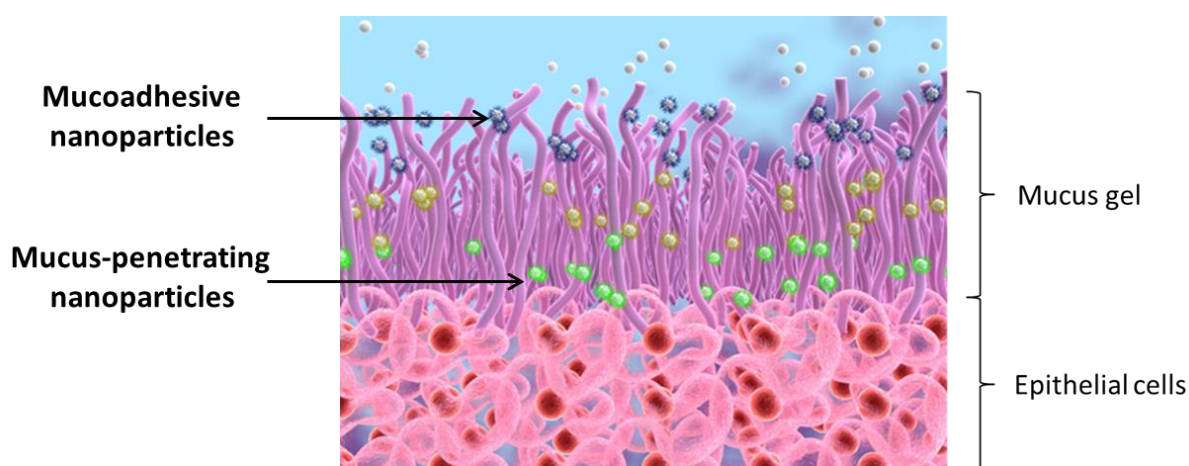

Figure 1. Schematic illustration of nanoparticles penetration through mucus lining. This image was produced by Ella Maru Studio, <http://www.scientific-illustrations.com/portfolio>

2. New polymers for developing mucus-penetrating nanoparticles

2.1. Poly(2-alkyl-2-oxazolines)

Poly(2-alkyl-2-oxazolines) (POZ) is a class of polymers with polypeptide-isomeric structures that have recently attracted a lot of attention as materials for biomedical applications [42-44]. The synthesis of these materials was first reported in the 1960s using cationic ring-opening polymerisation of different 2-oxazoline derivatives (**Figure 2**).

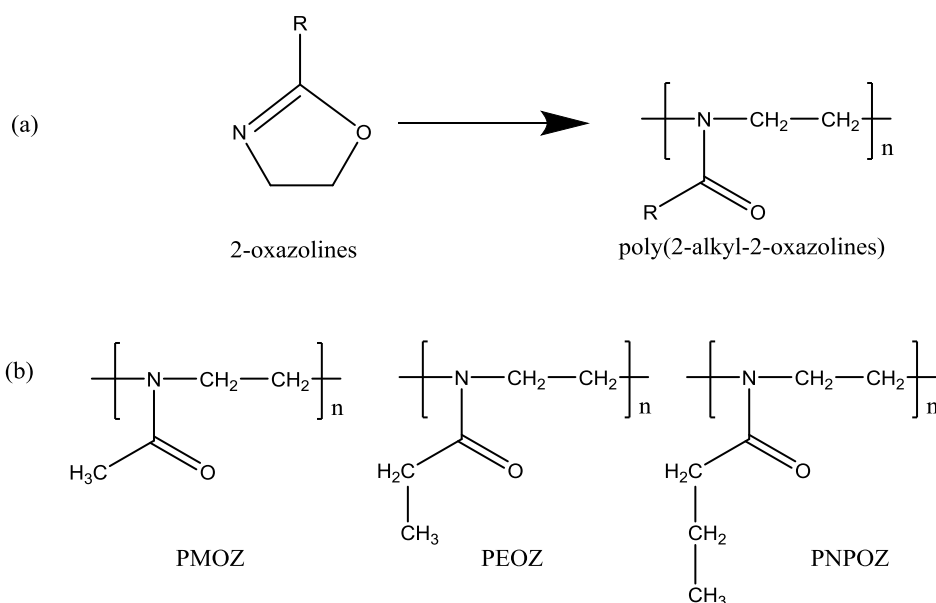

Figure 2. Synthesis of poly(2-alkyl-2-oxazolines) (a); structures of water-soluble poly(2-alkyl-2-oxazolines)

In recent years, poly(2-alkyl-2-oxazolines) were recognised as non-toxic and biocompatible materials with excellent “stealth” behaviour similar to PEG [42]. Methyl-, ethyl and n-propyl derivatives of POZ are soluble in water; PEOZ and PNPOZ exhibit lower critical solution temperature (LCST) in aqueous solutions at around 61-64 °C and 25-25 °C, respectively. Poly(2-alkyl-2-oxazolines) are not currently FDA approved; however, their extensive research for pharmaceutical applications may facilitate their regulatory clearance within the next few years [45]. In fact, some poly(2-ethyl-2-oxazoline)-containing formulations are currently undergoing clinical trials [46].

Mansfield et al [47, 48] reported the development of thiolated silica nanoparticles, their functionalisation with poly(2-methyl-2-oxazoline) (PMOZ), poly(2-ethyl-2-oxazoline) (PEOZ), and poly(2-n-propyl-2-oxazoline) (PNPOZ), *in vitro* diffusion studies in porcine gastric mucin dispersions, and *ex vivo* diffusion studies into porcine gastric mucus. Thiolated silica nanoparticles were synthesised by self-condensation of 3-mercaptopropyltrimethoxysilane (MPTS) in dimethylsulfoxide in the presence of atmospheric oxygen to mediate their partial cross-linking via disulfide bringing [49]. The presence of thiol groups on the surface of these nanoparticles ensured their excellent mucoadhesive properties [49, 50] and also provided opportunity for their surface PEGylation and POZylation by reactions with maleimide-terminated PEG and alkyne-terminated POZ. Mansfield et al [47, 48] studied the diffusion of these nanoparticles first in porcine gastric mucin dispersions

using nanoparticle tracking analysis, and then evaluated their penetration into freshly excised porcine stomach mucosa. **Figure 3** shows the diffusion coefficients of the nanoparticles in porcine gastric mucin and average distances travelled by the nanoparticles through mucus gel.

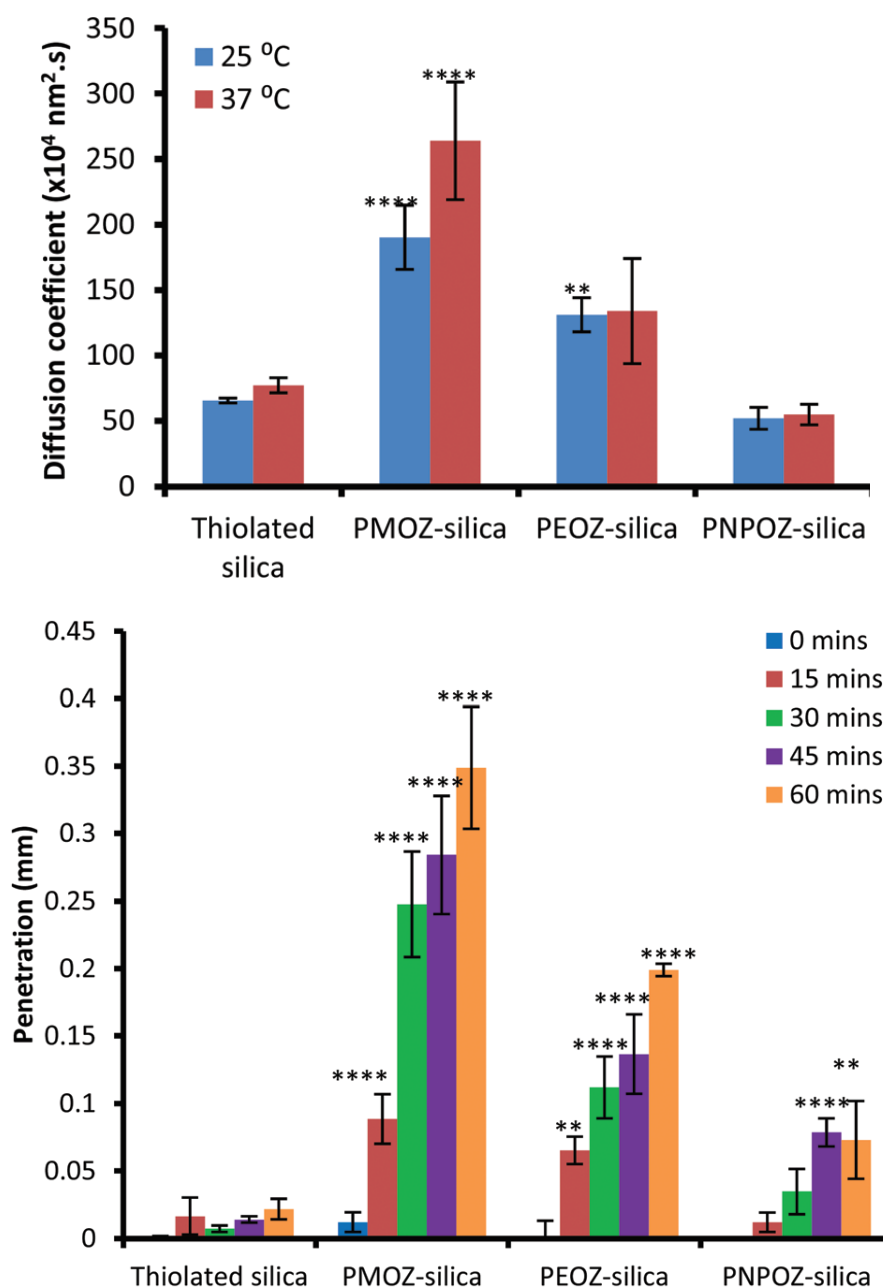

Figure 3. (a) Diffusion coefficients for thiolated, and poly(2-oxazoline)-functionalised silica nanoparticles through a 1% gastric mucin dispersion at 25 and 37 °C. Error bars represent the mean \pm standard deviation of 3 repeats; (b) *Ex vivo* penetration of thiolated and poly(2-oxazoline)-functionalised silica nanoparticles into porcine gastric mucosa over 1 hour. Values represent the mean penetration across 10 separate tissue sections \pm standard deviation.

Reprinted from *Biomater. Sci.*, 2016, 4, 1318–1327 [47] with permission by the Royal Society of Chemistry.

Both techniques demonstrated poor diffusivity of thiolated nanoparticles, which is consistent with their excellent mucoadhesive properties. The nanoparticles functionalised with PMOZ exhibited excellent mobility in the mucus, which was even superior to PEGylated sample of similar size. The nanoparticles with PEOZ surface were also significantly more diffusive compared to thiolated sample, but the ability of PEOZ to facilitate diffusion in the mucus was lower than what was recorded for PMOZ. The nanoparticles with PNPOZ surface did not show a significant difference in diffusion coefficient to the thiolated silica particles; however there was a significant difference in their penetration through gastric mucosa at longer time periods. Mansfield et al [47] related these observations to the changes in the hydrophobic–hydrophilic balance of poly(2-oxazolines): more hydrophilic polymers exhibited better ability to enhance mucus penetration.

2.2. Polypeptides and polypeptoids

Synthetic polypeptides and polypeptoids (**Figure 4**) are biodegradable biopolymers with structures mimicking natural proteins [51]. Polypeptoids is a class of pseudo-peptidic polymers that have an aliphatic polyamide backbone with some substitution on the nitrogen atoms [52].

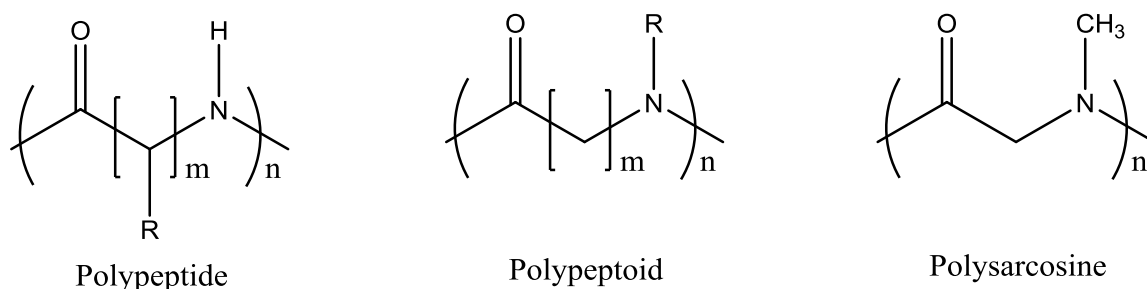

Figure 4. Structures of polypeptides, polypeptoids and polysarcosine (poly(N-methylglycine))

Polysarcosine (poly(N-methylglycine)) is a non-ionic water-soluble and biocompatible polypeptoid that has been explored for functionalisation of surfaces and nanoparticles for application in biomedicine [53, 54]. Lau et al [55] demonstrated that surface-grafted polysarcosine (PS) brushes exhibit excellent resistance to nonspecific protein adsorption and cell attachment. Although there are currently no reports on the use of PS or any other

polypeptoids for particle functionalisation to facilitate their diffusion through mucus, these materials are believed to be promising for application in transmucosal drug delivery.

2.3. Poly(vinyl alcohol)

Poly(vinyl alcohol) (PVA) is a non-ionic water-soluble polymer that has widely been used as a component of biomaterials and various drug delivery systems [56-61]. PVA often exhibits surface-active properties, making this polymer suitable as an emulsifier for stabilising various colloidal systems [62, 63].

PVA cannot be synthesised by direct polymerisation of vinyl alcohol because of unstable nature of this monomer [64]; instead this polymer is typically synthesised by polymerisation of poly(vinyl acetate), with its subsequent hydrolysis (saponification) to form poly(vinyl alcohol) (**Figure 5**). By this reason, PVA often contains residual vinyl acetate groups that greatly influence its physicochemical properties.

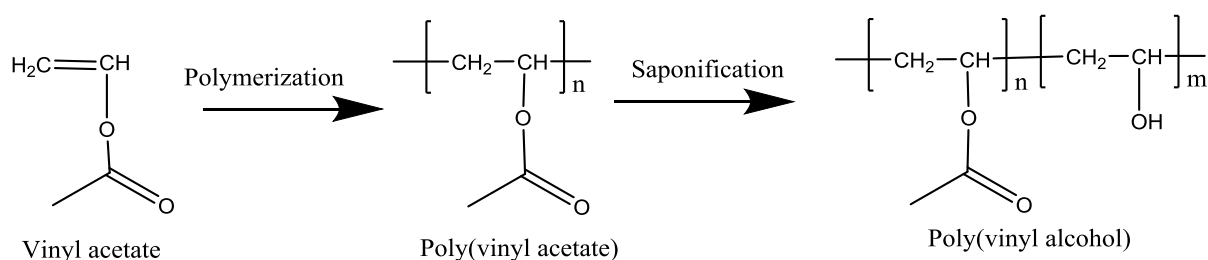

Figure 5. Synthesis and structure of poly(vinyl alcohol)

Another important feature of PVA is its semi-crystalline nature, which affects its solubility in water. PVA with larger molecular weights and higher degrees of crystallinity can be dissolved in water only upon heating to above 80-85 °C to disrupt strong intermolecular hydrogen bonding and crystallinity in solid polymer; subsequent cooling to a room temperature results in formation of stable aqueous solutions. Freezing aqueous solutions containing PVA and their subsequent thawing often results in formation of physically cross-linked cryogels, which could be used in drug delivery [65], biomaterials [66] and wound care [67]. PVA is a biocompatible and bioinert material, which makes this polymer to be highly suitable for many biomedical applications.

Yang et al [68] evaluated the diffusion of 200 nm carboxylated polystyrene nanoparticles coated with 2 kDa, 6 kDa, 25 kDa and 78 kDa PVA through human cervicovaginal mucus.

They also compared the behaviour of these particles with PEGylated polystyrene and PEGylated poly(lactide-co-glycolide) (PLGA) particles. They established that coating of carboxylated polystyrene nanoparticles with PVA of different molecular weight did not provide any improvement in their mucus diffusivity: there was no statistically significant difference between the mobility of carboxylated polystyrene and the nanoparticles coated with various grades of PVA in the mucus. Both carboxylated polystyrene and PVA-coated nanoparticles remained relatively immobile in the mucus, contrary to excellent diffusion properties of PEGylated nanoparticles of similar size. The authors have also evaluated the effect of PVA on mucus penetration properties of PEGylated PLGA nanoparticles. The deposition of PVA on the surface of PEGylated PLGA dramatically reduced their mucus penetration ability. The authors concluded that PVA exhibits mucoadhesive properties regardless of its molecular weight; these properties are likely to be due to the ability of this polymer to form hydrogen bonds and hydrophobic contacts with the components of the mucus gel. They also demonstrated that the degree of PVA deacetylation has a strong effect on the diffusivity of PVA-coated particles in the mucus. Polystyrene nanoparticles coated with 25 kDa 98% hydrolysed PVA were found to show greater mucus diffusivity compared to 25 kDa 88% hydrolysed PVA.

More recently, Popov et al [69] reported a more detailed *ex vivo* study exploring the effect of 10 different grades of PVA on the diffusivity of carboxylated polystyrene and polylactide (PLA) nanoparticles in ovulatory human cervicovaginal mucus. They prepared polystyrene particles coated with PVA by incubation of carboxylated polystyrene particles in PVA solutions (0.4-0.5% w/w) in deionised water for 24 hours at room temperature. The PVA-coated PLA nanoparticles were prepared by emulsification-evaporation procedure involving dissolution of PLA in dichloromethane, its emulsification in aqueous solution of PVA, sonication and subsequent rotary evaporation. It was established that some nanoparticles coated with PVA exhibited excellent ability to move through cervicovaginal mucus similarly to control PEGylated polystyrene particles; whereas other samples were mostly immobilised in the mucus. **Figure 6** shows the map of the ability PVA coated nanoparticles to exhibit mucus-penetration or mucoadhesion as a function of PVA molecular weight and degree of hydrolysis. The PVAs with the degree of hydrolysis > 90% were found to be mucoadhesive and the PVAs containing greater number of residual vinyl acetate groups exhibited mucus penetration character. The authors related this observation to relatively hydrophobic properties of vinyl acetate that provide better shielding effect, which prevents this polymer

from hydrogen bonding with mucins. It should be noted that the results of Popov et al [69] contradict some of the findings reported by Yang et al [68]. Popov et al [69] explained this discrepancy by the difference in the particle purification protocols used resulting in a different density of PVA coating.

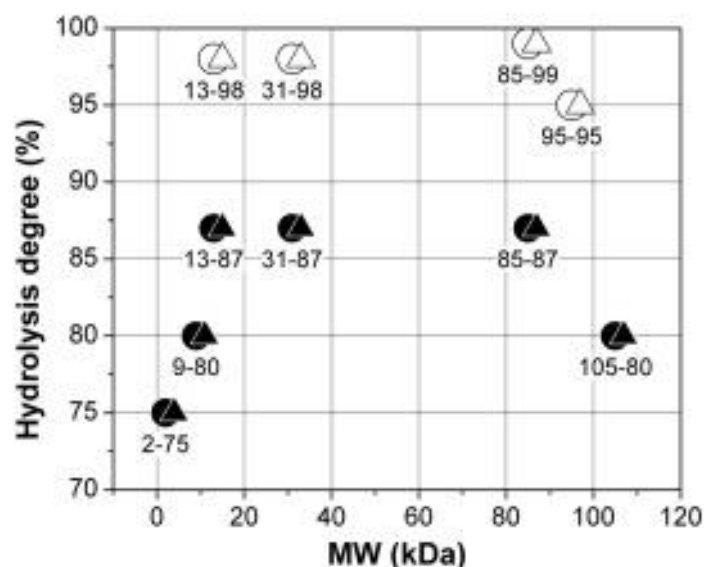

Figure 6. Mucus-penetrating (solid symbols) and mucoadhesive (open symbols) behaviour of nanoparticles mapped with regard to the PVA’s molecular weight (MW) and hydrolysis degree (degree of deacetylation). Circles represent carboxylated polystyrene nanoparticles incubated with various PVAs; Triangles represent PLA nanoparticles prepared by emulsification with various PVAs. Essentially identical behaviour was observed in both systems: PVAs with hydrolysis degrees < 95% and at least as low as 75%, regardless of their MW, produced particles as mobile (or nearly as mobile) in cervicovaginal mucus as the positive control (PEGylated polystyrene nanoparticles). Reprinted from *Nanomedicine: Nanotechnology, Biology and Medicine*, Vol 12, A. Popov, E. Enlow, J. Bourassa, H. Chen, Mucus-penetrating nanoparticles made with “mucoadhesive” poly(vinyl alcohol), 1863-1871 [69], Copyright (2016), with permission from Elsevier.

More studies will be necessary to evaluate the mucus-penetrating potential of PVA. These studies should include different mucosal routes and should also use better defined PVA samples. Some methods for the synthesis of well-defined PVA were developed [70, 71],

which could be useful for producing PVA samples with controlled molecular weights and polydispersities.

2.4. Other polymers with hydroxyl side groups

Poly-(N-(2-hydroxypropyl)methacrylamide) (PHPMA) is another water-soluble polymer that was first synthesized by Kopeček et al in 1973 and was extensively studied for various biomedical applications (**Figure 7**) [72]. PHPMA can be easily synthesised using conventional free radical polymerisation, atom transfer radical polymerisation (ATRP), and reversible addition-fragmentation chain transfer (RAFT) polymerisation of N-(2-hydroxypropyl)methacrylamide) [73]. The reactive hydroxyl group present in PHPMA can be subsequently exploited for further polymer functionalisation by conjugation with drugs, fluorescent labels, and other useful functional molecules. PHPMA has a number of advantages over PEG, as it does not show dose-dependent immunoresponses, rapid clearance after repeated injections, and potential oxidation. PHPMA also exhibits “stealth” properties similar to PEG [74, 75]. PHPMA has found applications for development of polymer-drug and polymer-protein conjugates, self-assembled nanoparticles, hydrogels and other systems [72, 73].

Shan et al [76] reported the development of self-assembled nanoparticles with excellent mucus permeating properties for oral delivery of insulin. The nanoparticles were prepared by mixing the aqueous solutions of insulin with penetratin, a polycationic peptide with cell-penetrating properties. The positively-charged nanocomplexes formed were then added to the solutions of negatively-charged HPMA copolymers with N-methacryloylglycylglycine (MAGG) of different HPMA:MAGG compositions (**Figure 7**). This has resulted in the deposition of HPMA-MAGG macromolecules on the surface of nanocomplexes and formation of PHPMA-based coating. Formation of this PHPMA-coating has resulted in the increase in the particle size from the original 148 nm to approximately 175 nm. The nanoparticles were tested for their permeation through porcine intestinal mucus mounted between semipermeable membranes using Ussing diffusion chamber. Additionally, the diffusivity of nanoparticles was also evaluated using multiple-particle tracking (MPT) method. The nanoparticles coated with less negatively charged HPMA-MAGG copolymers (containing lower quantities of MAGG) demonstrated better ability to diffuse through the mucus. The extra advantage of this system is the detachment of HPMA-MAGG

macromolecules in the mucus and release of insulin nanocomplexes with penetratin-functionalised surface, which facilitates their subsequent penetration into cells. These nanoparticles exhibited 20-fold greater absorption by mucus-secreting epithelium cells compared to free insulin and generated a substantial hypoglycemic response when orally administered in diabetic rats.

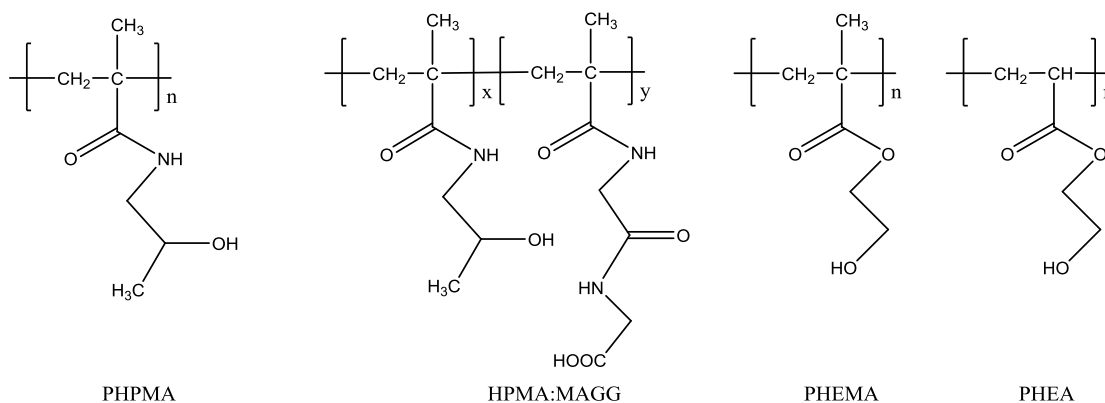

Figure 7. Structures of PHPMA, HPMA:MAGG copolymers, PHEMA and PHEA

More recently, Liu et al [77] reported a similar study, where insulin was incorporated into the core nanocomplex particles formed by trimethylchitosan and tripolyphosphate, which were subsequently coated with HPMA:MAGG (80:20 %) copolymer. The diffusion of the resulting nanoparticles through human cervicovaginal mucus was studied using MPT and Ussing chamber, similarly to [76]. The ensemble-averaged mean squared displacement ($\langle MSD \rangle$) values determined using MPT technique for the diffusion in the mucus were found to be 9.6-fold greater for the nanoparticles coated with HPMA:MAGG compared to uncoated particles. The apparent permeability coefficient of the nanoparticles coated with HPMA:MAGG was also 4.56-fold greater than for the core trimethylchitosan-tripolyphosphate nanoparticles, when estimated in a diffusion experiment using Ussing chamber. Both types of nanoparticles (coated and uncoated) were studied in vivo using diabetic rats. An oral administration of the nanoparticles with insulin demonstrated advantage in reducing blood glucose levels compared to free insulin solutions. The nanoparticles coated with HPMA:MAGG provided a larger relative bioavailability of 8.56% compared to 3.09% observed for uncoated particles at the dose of 50 IU/kg.

In a subsequent study, Liu et al [78] explored the role of HPMA:MAGG molecular weight ranging within 17 to 120 kDa in the diffusion through mucus and epithelial cells. They used core-particles reported in [77] and coated them with HPMA:MAGG of different molecular

weights. The nanoparticles coated with 17 kDa HPMA:MAGG exhibited better permeability through mucus and highest stability. However, the best molecular weight of HPMA:MAGG to promote cell uptake was 26 kDa.

Other hydrophilic polymers containing pendant hydroxyl groups are poly(2-hydroxyethylmethacrylate) (HEMA) and poly(2-hydroxyethylacrylate) (PHEA) (**Figure 7**). PHEMA is a well-established hydrophilic polymer widely used for biomedical applications. The main areas of PHEMA applications include soft contact lenses, drug delivery devices and dental composites [79]. Although 2-hydroxyethylmethacrylate monomer is fully soluble in water, its linear polymer is insufficiently hydrophilic and swells in water to produce a gel. PHEA is more hydrophilic than PHEMA and it is fully soluble in water. To the best of our knowledge, there are currently no studies on the use of either PHEMA or PHEA to modify nanoparticle surfaces to facilitate their penetration through mucus. However, a recent study of the behaviour of HEMA:HEA copolymeric hydrogels in solutions of lysozyme indicated that the copolymers containing higher levels of HEA have a greater resistance to protein deposition [80]. This indicates that more hydrophilic PHEA will possibly be another mucus-inert polymer that should facilitate penetration of PHEA-decorated nanoparticles through mucosal surfaces. Recent advances in controlled (co)polymerization of both 2-hydroxyethylmethacrylate and 2-hydroxyethylacrylate using ATRP [81], nitroxide-mediated radical polymerization [82] and RAFT techniques [83] can provide these polymers with various well-defined architecture and low molecular weights required for the design of mucus-penetrating nanoparticles.

Polyglycidols (PGs) are hydrophilic aliphatic polyether polyols that can potentially be synthesised with both branched and linear architecture (**Figure 8**) [84]. These materials were found to be highly biocompatible in a variety of both in vitro and in vivo assays [85]. In a study of protein adsorption, PG monolayers were found to be resistant similarly to PEG and are significantly better than dextran [86]. PGs were also considered as a potential alternative to PEG to protect surfaces of nanoparticles and ensure their “stealth” character [87].

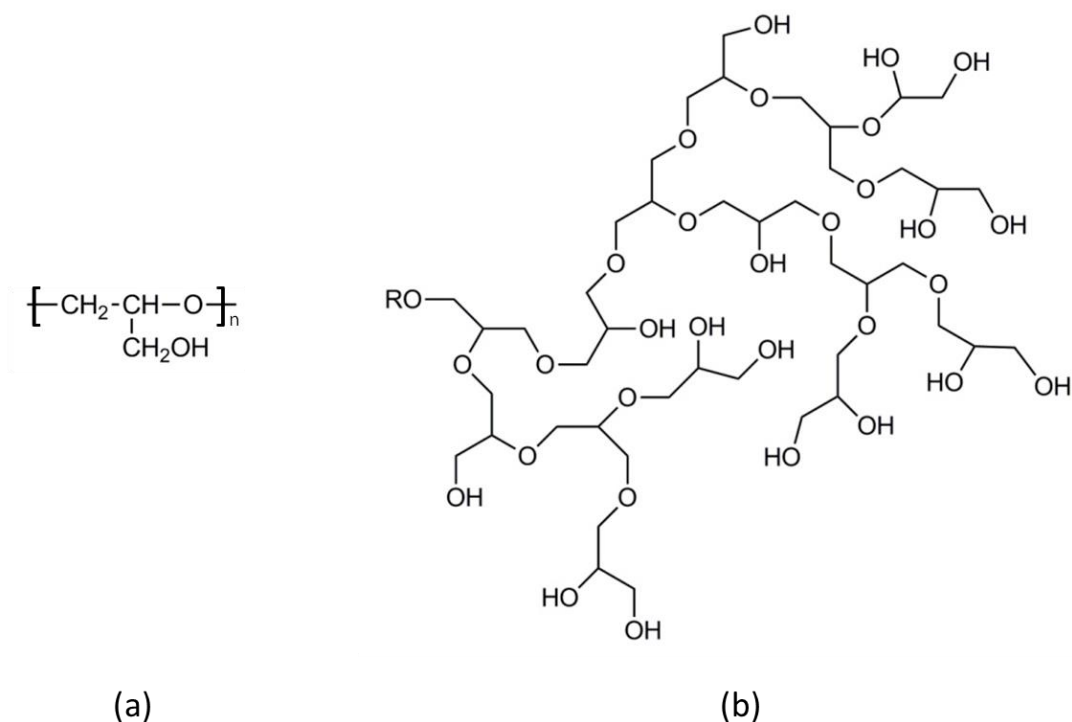

Figure 8. Structures of linear (a) and branched (b) polyglycidols. These structures reprinted from M. Gosecki, M. Gadzinowski, M. Gosecka, T. Basinska and S. Slomkowski, Polyglycidol, Its Derivatives, and Polyglycidol-Containing Copolymers—Synthesis and Medical Applications, *Polymers* 2016, 8(6), 227 under ©2016 by MDPI (<http://www.mdpi.org>).

Some polysaccharides such as low molecular weight dextran can also be expected to exhibit mucus-inert properties. Dextran is often used as a negative control in the studies of liquid and semisolid formulations due to its poor mucoadhesive properties [88, 89]. There are also reports on improved nanoparticles mobility in the mucus, mediated by guluronate oligomers prepared by acid hydrolysis of alginates [90].

2.5. Zwitterionic polymers

Zwitterionic polymers or polybetains are defined as materials, whose macromolecules have both anionic and cationic groups within their repeating unit [91-93]. Zwitterionic polymers have numerous technical applications including ion exchange raisins, chelators for water purification, sewage treatment, soil conditioning, reinforcement of paper, pigment retention,

and formulation in shampoos and hair conditioners [91]. Due to excellent biocompatibility, bioinert nature and hydrophilicity some polybetaines have found applications as coatings for biomedical devices, drug delivery systems, and bioconjugates [92]. **Figure 9** schematically shows various potential structures for polybetaines. Depending on the nature of ionic groups, polybetaines may be classified into polycarboxybetaines, polysulfobetaines, and polyphosphobetaines.

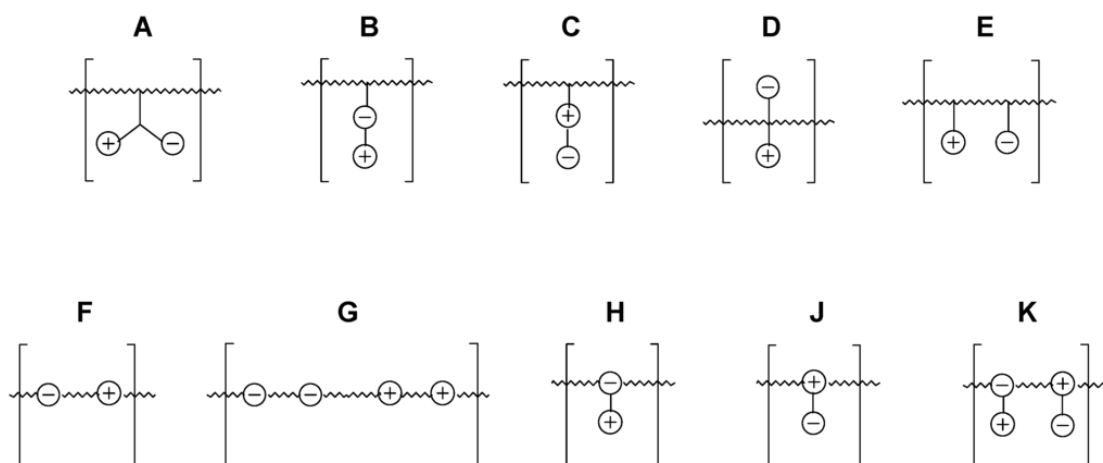

Figure 9. Distribution of ionic groups within polyzwitterionic polymers. Reprinted from A. Laschewsky, Structures and Synthesis of Zwitterionic Polymers, *Polymers* 2014, 6(5), 1544-1601 [93] under ©2014 by MDPI (<http://www.mdpi.org>).

There are a number of studies demonstrating that polybetaines have a “stealth” character and can greatly reduce non-specific protein adsorption, bacterial adhesion and biofilm formation [87]. For example, Yang et al [94] demonstrated that the nanoparticles coated with zwitterionic poly(carboxybetaine acrylamide) exhibit excellent stability in undiluted human blood serum and have superior performance compared to PEGylated particles.

Shan et al [95] reported the design of self-assembled nanoparticles decorated with zwitterionic groups derived from dilauroylphosphatidylcholine (DLPC). They studied the effect of DLPC coating on the mucus permeation, cellular uptake and in vivo efficacy in oral delivery of insulin. The nanoparticles were prepared by mixing porcine insulin, poly(lactic acid) (PLA) and DLPC in dimethylsulfoxide. This mixture was then added to deionised water to cause precipitation and formation of nanoparticles. They studied these nanoparticles in comparison with PLA coated with Pluronic F127 (to result in PEGylated surfaces) and PVA. Mucus permeation studies were performed using four different approaches – mucin affinity

analysis, modified fluorescence recovery after photobleaching (FRAP) analysis, mucus diffusion analysis and small intestinal biodistribution study in vivo. Both DLPC-coated and PEGylated particles exhibited minimal interaction with purified porcine mucin; however, PVA-coated particles caused 10-fold greater aggregation in 0.1 % mucin solution compared to DLPC-decorated particles. The FRAP analysis also demonstrated greater mobility of DLPC-coated and PEGylated particles compared to PVA-coated ones. The experiment on mucus diffusion estimated the apparent permeability coefficient of the nanoparticles and revealed 6.3-fold greater diffusivity of DLPC-coated system compared to the particles coated with PVA. In vivo biodistribution study performed in mice indicated that PVA-coated nanoparticles covered only 32.3±4.2 % of intestinal epithelium surface; whereas DLPC-decorated and PEGylated particles gave 69.0±4.6 % and 73.0±5.0% surface coverage, respectively. Excellent diffusivity of the nanoparticles through mucus provided better intestinal distribution to ensure good therapeutic efficiency. The nanoparticles with zwitterionic surfaces also exhibited greater cellular uptake, which was more efficient than for PEGylated particles. In vivo oral administration of insulin-loaded zwitterionic nanoparticles in diabetic rats resulted in a greater bioavailability compared to PEGylated and PVA-decorated nanoparticles as well as free insulin.

3. Nanoparticles decorated with proteolytic enzymes

Nanoparticles with enhanced mucus-penetrating properties could be designed not only using mucus-inert polymers but also active functional moieties, for example, mucolytic enzymes. Bernkop-Schnürch and co-workers [96] developed nanoparticles functionalised with papain, an enzyme with mucolytic activity. Papain was covalently linked to poly(acrylic acid) and calcium chloride solution was then added dropwise to the resulting enzyme-polymer conjugate to form nanoparticles as shown in **Figure 10**.

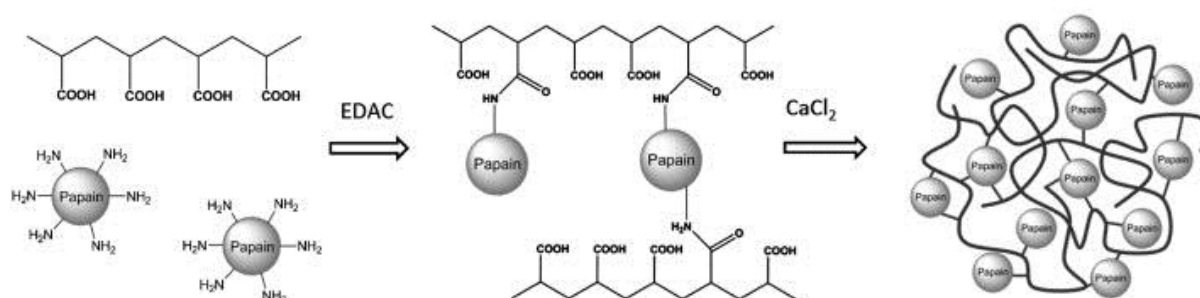

Figure 10. Scheme of synthesis of nanoparticles decorated with papain. Reprinted from European Journal of Pharmaceutics and Biopharmaceutics, Volume 87, Issue 1, Christiane Müller, Glen Perera, Verena König, Andreas Bernkop-Schnürch “Development and in vivo evaluation of papain-functionalized nanoparticles”, 125–131, ©2014 [96], with permission from Elsevier.

The resulting nanoparticles were of 190-230 nm and had a negative zeta potential. For the mucus diffusion studies these nanoparticles were also loaded with fluorescein diacetate as a fluorescent marker. The rheological measurements indicated that the nanoparticles added to porcine intestinal mucus lead to a significant loss of its viscoelastic properties. The parent PAA without papain did not cause this dramatic reduction in mucus relative viscosity. The in vitro diffusion of the nanoparticles was studied using modified Transwell-Snapwell diffusion chambers and these experiments demonstrated that the nanoparticles formed by papain-polymer conjugates have a 3.0-fold greater diffusivity compared to the particles formed by parent poly(acrylic acid). These nanoparticles together with several controls were encapsulated into enterically-coated microcapsules and studied in vivo experiments in rats using oral dosing. It was demonstrated that the nanoparticles with conjugated papain had a greater penetration through the mucus layer of proximal segments of the intestinal tract.

In a subsequent study Bernkop-Schnürch and co-workers [97] have reported a comparison between the nanoparticles formed by poly(acrylic acid) conjugated with papain and bromelain. These studied the diffusivity of both types of nanoparticles and control samples in vitro using the rotating tube technique [98] and also pulsed-gradient spin-echo NMR spectroscopy [99]. The nanoparticles decorated with proteolytic enzymes exhibited greater mucus permeation compared to the particles formed by parent poly(acrylic acid) and bromelain-decorated particles were found to be more efficient than the particles with papain.

4. Comparison of different systems

Different polymer and biopolymer systems were considered in the previous sections as potential materials for surface modification of nanoparticles to facilitate their mucus penetration. This section will present a comparison of these materials and will discuss their advantages and disadvantages (Table 1).

Table 1. Comparison of different materials used for design of mucus-penetrating particles

Materials used for functionalisation of nanoparticle surfaces	References to the studies reporting their use to facilitate mucus-penetration	Advantages	Disadvantages
PEG	[31, 34]	The gold standard for stealth polymers in drug delivery [100]; FDA approved status [101]; excellent track record of applications in the design of mucus-penetrating particles	Limited chemical stability, particularly due to oxidative degradation [102]; limited excretion from the body as for other polymers [101]
POZ	[47, 48]	A facile synthesis; possibility for further functionalisation [42]; a high degree of renal clearance with no bioaccumulation [103]; and improved stability against oxidative degradation [102].	Not approved by FDA yet
PS	*	“Stealth” properties analogous to PEG (i.e., long circulation times and limited nonspecific organ uptake) [52]	Only few studies reporting the biomedical applications of PS

PVA	[68, 69]	Generally Recognised as Safe (GRAS) by the FDA and approved for many pharmaceutical applications [69]; excellent surface-active properties and good track record of applications as a stabilizer and emulsifier	Strong dependence of physicochemical and biological properties on the degree of deacetylation
PHPMA	[76-78]	Widely explored as a carrier for anticancer agents with several products currently progressed through clinical trials [104]	Non-biodegradable nature of this polymer and its derivatives may limit some clinical applications [105]; relatively expensive polymer compared to PEGs
PHEMA and PHEA	*	Excellent biocompatibility of PHEMA with a proven non-irritation potential for mucosal tissues (e.g. application in contact lens industry) [61, 79].	PHEMA is relatively hydrophobic and is not soluble in water. This may hamper diffusion of PHEMA decorated nanoparticles through mucus. Lack of biomedical studies involving PHEA
PGs	*	Less susceptible to oxidation or thermal stress than PEG [86].	Only a few studies reporting the use of PGs in drug delivery [106].
Zwitterionic polymers	[95]	These materials bind water molecules stronger than conventional water-soluble polymers such as PEG; they provide electrostatically induced	Current lack of studies reporting the use of zwitterionic polymers in drug delivery

		hydration that prevents adsorption of proteins, cells, and bacteria on surfaces; poly(carboxybetaine) has better chemical stability compared to PEG [107]	
Proteolytic enzymes	[96, 97]	Provides mucolytic effects in addition to enhancing mucus penetration	Potential issues with product long term stability as enzymatic activity may decrease with time

*No particle permeation studies reported

5. Conclusions

PEGylated nanoparticles have been exploited as potential strategy to facilitate diffusion through mucosal barriers. Excellent biocompatibility, mucus inert nature and stealth character of PEGs ensure their application in the design of mucus-penetrating particles. Recent advances in the synthetic polymer and colloidal chemistry identified a number of water-soluble polymers that could be used as alternatives to PEGs. Some classes of polymers such as poly(2-alkyl-2-oxazolines), poly(vinyl alcohols), other hydroxyl containing polymers and polybetains have been explored in their potential to facilitate diffusion through mucosal barriers. Some other materials such as polysarcosine, poly(2-hydroxyethyl(meth)acrylates) and polyglycydol could potentially be explored for this application. There are still relatively few studies on the use of these polymers in the design of nanoparticles with enhanced mucus penetration. In some of these studies polymers were physically bound to particle surfaces to facilitate their diffusion (some of these macromolecules were even able to detach from the particles during their transit through the mucus); other reports describe chemical conjugation strategies in the design of mucus-penetrating systems. The general features of mucus-inert polymers suitable for the design of mucus-penetrating particles are their relatively low molecular weight, highly hydrophilic and non-charged nature. These polymers must be either fully non-ionic or should have a fully balanced number of positively and negatively-charged groups as in zwitterions. Methods of controlled polymerization developed in recent years

could help in the synthesis of well-defined mucus-inert polymers with low molecular weight and narrow polydispersity, which will facilitate the design of advanced mucus-penetrating drug delivery systems.

In addition to mucus-inert polymers used for functionalisation of nanoparticles, other strategies could be used to enhance their penetration through mucosal barriers. One of the strategies is the application of mucolytic enzymes.

It should also be noted that different research groups use a variety of techniques and mucus samples to study nanoparticle diffusion. The difference in these approaches may also affect the results greatly, and the direct comparison between the polymers that provide mucus-penetrating properties is often difficult.

6. References

- [1] V.V. Khutoryanskiy, *Advances in Mucoadhesion and Mucoadhesive Polymers*, *Macromol Biosci*, 11 (2011) 748-764.
- [2] V.V. Khutoryanskiy, *Mucoadhesive Materials and Drug Delivery Systems Preface*, *Mucoadhesive Materials and Drug Delivery Systems*, (2014) Xvii-Xviii.
- [3] G.P. Andrews, T.P. Laverty, D.S. Jones, *Mucoadhesive polymeric platforms for controlled drug delivery*, *Eur J Pharm Biopharm*, 71 (2009) 505-518.
- [4] N.A. Peppas, J.B. Thomas, J. McGinty, *Molecular Aspects of Mucoadhesive Carrier Development for Drug Delivery and Improved Absorption*, *J Biomat Sci-Polym E*, 20 (2009) 1-20.
- [5] A.R. Mackie, F.M. Goycoolea, B. Menchicchi, C.M. Caramella, F. Saporito, S. Lee, K. Stephansen, I.S. Chronakis, M. Hiorth, M. Adamczak, M. Waldner, H.M. Nielsen, L. Marcelloni, *Innovative Methods and Applications in Mucoadhesion Research*, *Macromol Biosci*, (2017).
- [6] E. Mathiowitz, D.E. Chickering, C.-M. Lehr, *Bioadhesive drug delivery systems : fundamentals, novel approaches, and development*, Marcel Dekker, New York, 1999.
- [7] V. Lenaerts, R. Gurny, *Bioadhesive drug delivery systems*, CRC Press, Boca Raton, Fla., 1990.
- [8] S. Duggan, W. Cummins, O. O'Donovan, H. Hughes, E. Owens, *Thiolated polymers as mucoadhesive drug delivery systems*, *Eur J Pharm Sci*, 100 (2017) 64-78.
- [9] S. Lindert, J. Breitreutz, *Oromucosal multilayer films for tailor-made, controlled drug delivery*, *Expert opinion on drug delivery*, (2017) 1-15.
- [10] A. Partenhauser, A. Bernkop-Schnurch, *Mucoadhesive polymers in the treatment of dry X syndrome*, *Drug discovery today*, 21 (2016) 1051-1062.
- [11] P. Schattling, E. Taipaleenmaki, Y. Zhang, B. Stadler, *A Polymer Chemistry Point of View on Mucoadhesion and Mucopenetration*, *Macromol Biosci*, (2017).
- [12] P.W. Morrison, V.V. Khutoryanskiy, *Advances in ophthalmic drug delivery*, *Therapeutic delivery*, 5 (2014) 1297-1315.
- [13] B.M. Davis, E.M. Normando, L. Guo, L.A. Turner, S. Nizari, P. O'Shea, S.E. Moss, S. Somavarapu, M.F. Cordeiro, *Topical Delivery of Avastin to the Posterior Segment of the Eye In Vivo Using Annexin A5-associated Liposomes*, *Small*, 10 (2014) 1575-1584.
- [14] M. Kapoor, J.C. Cloyd, R.A. Siegel, *A review of intranasal formulations for the treatment of seizure emergencies*, *J Control Release*, 237 (2016) 147-159.

- [15] L. Kozlovskaya, M. Abou-Kaoud, D. Stepensky, Quantitative analysis of drug delivery to the brain via nasal route, *J Control Release*, 189 (2014) 133-140.
- [16] M.T. Cook, S.A. Schmidt, E. Lee, W. Samprasit, P. Opanasopit, V.V. Khutoryanskiy, Synthesis of mucoadhesive thiol-bearing microgels from 2-(acetylthio)ethylacrylate and 2-hydroxyethylmethacrylate: novel drug delivery systems for chemotherapeutic agents to the bladder, *J Mater Chem B*, 3 (2015) 6599-6604.
- [17] S. GuhaSarkar, R. Banerjee, Intravesical drug delivery: Challenges, current status, opportunities and novel strategies, *J Control Release*, 148 (2010) 147-159.
- [18] K.R. Bhaskar, P. Garik, B.S. Turner, J.D. Bradley, R. Bansil, H.E. Stanley, J.T. Lamont, Viscous Fingering of Hcl through Gastric Mucin, *Nature*, 360 (1992) 458-461.
- [19] M.T. Cook, G. Tzortzis, D. Charalampopoulos, V.V. Khutoryanskiy, Microencapsulation of probiotics for gastrointestinal delivery, *J Control Release*, 162 (2012) 56-67.
- [20] J. das Neves, M. Amiji, B. Sarmento, Mucoadhesive nanosystems for vaginal microbicide development: friend or foe?, *Wires Nanomed Nanobi*, 3 (2011) 389-399.
- [21] S.K. Lai, Y.Y. Wang, J. Hanes, Mucus-penetrating nanoparticles for drug and gene delivery to mucosal tissues, *Adv Drug Deliver Rev*, 61 (2009) 158-171.
- [22] H.H. Sigurdsson, J. Kirch, C.M. Lehr, Mucus as a barrier to lipophilic drugs, *Int J Pharmaceut*, 453 (2013) 56-64.
- [23] M. Ruponen, A. Urtti, Undefined role of mucus as a barrier in ocular drug delivery, *Eur J Pharm Biopharm*, 96 (2015) 442-446.
- [24] A. Sosnik, J. das Neves, B. Sarmento, Mucoadhesive polymers in the design of nano-drug delivery systems for administration by non-parenteral routes: A review, *Prog Polym Sci*, 39 (2014) 2030-2075.
- [25] C.S. Schneider, Q. Xu, N.J. Boylan, J. Chisholm, B.C. Tang, B.S. Schuster, A. Henning, L.M. Ensign, E. Lee, P. Adstamongkonkul, B.W. Simons, S.S. Wang, X. Gong, T. Yu, M.P. Boyle, J.S. Suk, J. Hanes, Nanoparticles that do not adhere to mucus provide uniform and long-lasting drug delivery to airways following inhalation, *Science advances*, 3 (2017) e1601556.
- [26] N.N. Sanders, S.C. De Smedt, E. Van Rompaey, P. Simoens, F. De Baets, J. Demeester, Cystic fibrosis sputum - A barrier to the transport of nanospheres, *Am J Resp Crit Care*, 162 (2000) 1905-1911.
- [27] P.G. Bhat, D.R. Flanagan, M.D. Donovan, Drug diffusion through cystic fibrotic mucus: Steady-state permeation, rheologic properties, and glycoprotein morphology, *J Pharm Sci*, 85 (1996) 624-630.
- [28] K.J. Whaley, J. Hanes, R. Shattock, R.A. Cone, D.R. Friend, Novel Approaches to Vaginal Delivery and Safety of Microbicides: Biopharmaceuticals, Nanoparticles, and Vaccines, *Antivir Res*, 88 (2010) S55-S66.
- [29] D. Lopes, C. Nunes, M.C.L. Martins, B. Sarmento, S. Reis, Eradication of *Helicobacter pylori*: Past, present and future, *J Control Release*, 189 (2014) 169-186.
- [30] Y.Y. Wang, S.K. Lai, J.S. Suk, A. Pace, R. Cone, J. Hanes, Addressing the PEG Mucoadhesivity Paradox to Engineer Nanoparticles that "Slip" through the Human Mucus Barrier, *Angew Chem Int Edit*, 47 (2008) 9726-9729.
- [31] M. Yang, S.K. Lai, Y.Y. Wang, W.X. Zhong, C. Happe, M. Zhang, J. Fu, J. Hanes, Biodegradable Nanoparticles Composed Entirely of Safe Materials that Rapidly Penetrate Human Mucus, *Angew Chem Int Edit*, 50 (2011) 2597-2600.
- [32] O. Mert, S.K. Lai, L. Ensign, M. Yang, Y.Y. Wang, J. Wood, J. Hanes, A poly(ethylene glycol)-based surfactant for formulation of drug-loaded mucus penetrating particles, *J Control Release*, 157 (2012) 455-460.
- [33] Q.G. Xu, N.J. Boylan, S.T. Cai, B. Miao, H. Patel, J. Hanes, Scalable method to produce biodegradable nanoparticles that rapidly penetrate human mucus, *J Control Release*, 170 (2013) 279-286.

- [34] S.K. Lai, D.E. O'Hanlon, S. Harrold, S.T. Man, Y.Y. Wang, R. Cone, J. Hanes, Rapid transport of large polymeric nanoparticles in fresh undiluted human mucus, *P Natl Acad Sci USA*, 104 (2007) 1482-1487.
- [35] K. Maisel, M. Reddy, Q.G. Xu, S. Chattopadhyay, R. Cone, L.M. Ensign, J. Hanes, Nanoparticles coated with high molecular weight PEG penetrate mucus and provide uniform vaginal and colorectal distribution in vivo, *Nanomedicine-Uk*, 11 (2016) 1337-1343.
- [36] J.S. Suk, S.K. Lai, N.J. Boylan, M.R. Dawson, M.P. Boyle, J. Hanes, Rapid transport of muco-inert nanoparticles in cystic fibrosis sputum treated with N-acetyl cysteine, *Nanomedicine-Uk*, 6 (2011) 365-375.
- [37] L.M. Ensign, R. Cone, J. Hanes, Oral drug delivery with polymeric nanoparticles: The gastrointestinal mucus barriers, *Adv Drug Deliver Rev*, 64 (2012) 557-570.
- [38] I.P. de Sousa, T. Moser, C. Steiner, B. Fichtl, A. Bernkop-Schnurch, Insulin loaded mucus permeating nanoparticles: Addressing the surface characteristics as feature to improve mucus permeation, *Int J Pharmaceut*, 500 (2016) 236-244.
- [39] Q.G. Xu, N.J. Boylan, J.S. Suk, Y.Y. Wang, E.A. Nance, J.C. Yang, P.J. McDonnell, R.A. Cone, E.J. Duh, J. Hanes, Nanoparticle diffusion in, and microrheology of, the bovine vitreous ex vivo, *J Control Release*, 167 (2013) 76-84.
- [40] N.N. Sanders, L. Peeters, I. Lentacker, J. Demeester, S.C. De Smedt, Wanted and unwanted properties of surface PEGylated nucleic acid nanoparticles in ocular gene transfer, *J Control Release*, 122 (2007) 226-235.
- [41] E.A. Mun, P.W.J. Morrison, A.C. Williams, V.V. Khutoryanskiy, On the Barrier Properties of the Cornea: A Microscopy Study of the Penetration of Fluorescently Labeled Nanoparticles, *Polymers*, and Sodium Fluorescein, *Mol Pharmaceut*, 11 (2014) 3556-3564.
- [42] R. Hoogenboom, Poly(2-oxazoline)s: A Polymer Class with Numerous Potential Applications, *Angew Chem Int Edit*, 48 (2009) 7978-7994.
- [43] O. Sedlacek, B.D. Monnery, S.K. Filippov, R. Hoogenboom, M. Hruby, Poly(2-Oxazoline)s - Are They More Advantageous for Biomedical Applications Than Other Polymers?, *Macromol Rapid Comm*, 33 (2012) 1648-1662.
- [44] T.X. Viegas, M.D. Bentley, J.M. Harris, Z.F. Fang, K. Yoon, B. Dizman, R. Weimer, A. Mero, G. Pasut, F.M. Veronese, Polyoxazoline: Chemistry, Properties, and Applications in Drug Delivery, *Bioconjugate Chem*, 22 (2011) 976-986.
- [45] M.N. Macgregor-Ramiasa, A.A. Cavallaro, K. Vasilev, Properties and reactivity of polyoxazoline plasma polymer films, *J Mater Chem B*, 3 (2015) 6327-6337.
- [46] Clinical trial number: NCT02579473, in.
- [47] E.D.H. Mansfield, V.R. de la Rosa, R.M. Kowalczyk, I. Grillo, R. Hoogenboom, K. Sillence, P. Hole, A.C. Williams, V.V. Khutoryanskiy, Side chain variations radically alter the diffusion of poly(2-alkyl-2-oxazoline) functionalised nanoparticles through a mucosal barrier, *Biomater Sci-Uk*, 4 (2016) 1318-1327.
- [48] E.D.H. Mansfield, K. Sillence, P. Hole, A.C. Williams, V.V. Khutoryanskiy, POZylation: a new approach to enhance nanoparticle diffusion through mucosal barriers, *Nanoscale*, 7 (2015) 13671-13679.
- [49] G.S. Irmukhametova, G.A. Mun, V.V. Khutoryanskiy, Thiolated Mucoadhesive and PEGylated Nonmucoadhesive Organosilica Nanoparticles from 3-Mercaptopropyltrimethoxysilane, *Langmuir*, 27 (2011) 9551-9556.
- [50] E.A. Mun, A.C. Williams, V.V. Khutoryanskiy, Adhesion of thiolated silica nanoparticles to urinary bladder mucosa: Effects of PEGylation, thiol content and particle size, *Int J Pharmaceut*, 512 (2016) 32-38.
- [51] T.J. Deming, Synthetic polypeptides for biomedical applications, *Prog Polym Sci*, 32 (2007) 858-875.
- [52] D.H. Zhang, S.H. Lahasky, L. Guo, C.U. Lee, M. Lavan, Polypeptoid Materials: Current Status and Future Perspectives, *Macromolecules*, 45 (2012) 5833-5841.

- [53] A. Fokina, K. Klinker, L. Braun, B.G. Jeong, W.K. Bae, M. Barz, R. Zentel, Multidentate Polysarcosine-Based Ligands for Water-Soluble Quantum Dots, *Macromolecules*, 49 (2016) 3663-3671.
- [54] H. Zhu, Y. Chen, F.J. Yan, J. Chen, X.F. Tao, J. Ling, B. Yang, Q.J. He, Z.W. Mao, Polysarcosine brush stabilized gold nanorods for in vivo near-infrared photothermal tumor therapy, *Acta Biomater*, 50 (2017) 534-545.
- [55] K.H.A. Lau, C.L. Ren, T.S. Sileika, S.H. Park, I. Szleifer, P.B. Messersmith, Surface-Grafted Polysarcosine as a Peptoid Antifouling Polymer Brush, *Langmuir*, 28 (2012) 16099-16107.
- [56] N. Ben Halima, Poly(vinyl alcohol): review of its promising applications and insights into biodegradation, *Rsc Adv*, 6 (2016) 39823-39832.
- [57] E.A. Kamoun, X. Chen, M.S.M. Eldin, E.R.S. Kenawy, Crosslinked poly(vinyl alcohol) hydrogels for wound dressing applications: A review of remarkably blended polymers, *Arab J Chem*, 8 (2015) 1-14.
- [58] G. Verstraete, W. De Jaeghere, J. Vercruyse, W. Grymonpre, V. Vanhoorne, F. Stauffer, T. De Beer, A. Bezuijen, J.P. Remon, C. Vervaet, The use of partially hydrolysed polyvinyl alcohol for the production of high drug-loaded sustained release pellets via extrusion-spheronisation and coating: In vitro and in vivo evaluation, *Int J Pharmaceut*, 517 (2017) 88-95.
- [59] W. De Jaeghere, T. De Beer, J. Van Bocxlaer, J.P. Remon, C. Vervaet, Hot-melt extrusion of polyvinyl alcohol for oral immediate release applications, *Int J Pharm*, 492 (2015) 1-9.
- [60] E. Calo, J.M.S. de Barros, M. Fernandez-Gutierrez, J. San Roman, L. Ballamy, V.V. Khutoryanskiy, Antimicrobial hydrogels based on autoclaved poly(vinyl alcohol) and poly(methyl vinyl ether-alt-maleic anhydride) mixtures for wound care applications, *Rsc Adv*, 6 (2016) 55211-55219.
- [61] E. Calo, V.V. Khutoryanskiy, Biomedical applications of hydrogels: A review of patents and commercial products, *Eur Polym J*, 65 (2015) 252-267.
- [62] L. Mu, S.S. Feng, Fabrication, characterization and in vitro release of paclitaxel (Taxol (R)) loaded poly (lactic-co-glycolic acid) microspheres prepared by spray drying technique with lipid/cholesterol emulsifiers, *J Control Release*, 76 (2001) 239-254.
- [63] R. Saadati, S. Dadashzadeh, Marked effects of combined TPGS and PVA emulsifiers in the fabrication of etoposide-loaded PLGA-PEG nanoparticles: In vitro and in vivo evaluation, *Int J Pharmaceut*, 464 (2014) 135-144.
- [64] P. Molyneux, *Water-soluble synthetic polymers : properties and behavior*, CRC Press, Boca Raton, Fla., 1984.
- [65] G.G. de Lima, R.O. de Souza, A.D. Bozzi, M.A. Poplawska, D.M. Devine, M.J.D. Nugent, Extraction Method Plays Critical Role in Antibacterial Activity of Propolis-Loaded Hydrogels, *J Pharm Sci*, 105 (2016) 1248-1257.
- [66] H.J. Jiang, G. Campbell, D. Boughner, W.K. Wan, M. Quantz, Design and manufacture of a polyvinyl alcohol (PVA) cryogel tri-leaflet heart valve prosthesis, *Med Eng Phys*, 26 (2004) 269-277.
- [67] E. Calo, J. Barros, L. Ballamy, V.V. Khutoryanskiy, Poly(vinyl alcohol)-Gantrez (R) AN cryogels for wound care applications, *Rsc Adv*, 6 (2016) 105487-105494.
- [68] M. Yang, S.K. Lai, T. Yu, Y.Y. Wang, C. Happe, W.X. Zhong, M. Zhang, A. Anonuevo, C. Fridley, A. Hung, J. Fu, J. Hanes, Nanoparticle penetration of human cervicovaginal mucus: The effect of polyvinyl alcohol, *J Control Release*, 192 (2014) 202-208.
- [69] A. Popov, E. Enlow, J. Bourassa, H.M. Chen, Mucus-penetrating nanoparticles made with "mucoadhesive" poly(vinyl alcohol), *Nanomed-Nanotechnol*, 12 (2016) 1863-1871.
- [70] T. Congdon, P. Shaw, M.I. Gibson, Thermoresponsive, well-defined, poly(vinyl alcohol) copolymers, *Polym Chem-Uk*, 6 (2015) 4749-4757.
- [71] O.A. Scherman, H.M. Kim, R.H. Grubbs, Synthesis of well-defined poly((vinyl alcohol)(2)-alt-methylene) via ring-opening metathesis polymerization, *Macromolecules*, 35 (2002) 5366-5371.
- [72] J. Kopecek, P. Kopeckova, HPMA copolymers: Origins, early developments, present, and future, *Adv Drug Deliver Rev*, 62 (2010) 122-149.
- [73] B.S. Tucker, B.S. Sumerlin, Poly(N-(2-hydroxypropyl) methacrylamide)-based nanotherapeutics, *Polym Chem-Uk*, 5 (2014) 1566-1572.

- [74] M. Talelli, C.J.F. Rijcken, C.F. van Nostrum, G. Storm, W.E. Hennink, Micelles based on HPMA copolymers, *Adv Drug Deliver Rev*, 62 (2010) 231-239.
- [75] N. Du, W.X. Guo, Q.S. Yu, S.L. Guan, L.Y. Guo, T. Shen, H. Tang, Z.H. Gan, Poly(D,L-lactic acid)-block-poly(N-(2-hydroxypropyl) methacrylamide) nanoparticles for overcoming accelerated blood clearance and achieving efficient anti-tumor therapy, *Polym Chem-Uk*, 7 (2016) 5719-5729.
- [76] W. Shan, X. Zhu, M. Liu, L. Li, J.J. Zhong, W. Sun, Z.R. Zhang, Y. Huang, Overcoming the Diffusion Barrier of Mucus and Absorption Barrier of Epithelium by Self-Assembled Nanoparticles for Oral Delivery of Insulin, *Acs Nano*, 9 (2015) 2345-2356.
- [77] M. Liu, J. Zhang, X. Zhu, W. Shan, L. Li, J.J. Zhong, Z.R. Zhang, Y. Huang, Efficient mucus permeation and tight junction opening by dissociable "mucus-inert" agent coated trimethyl chitosan nanoparticles for oral insulin delivery, *J Control Release*, 222 (2016) 67-77.
- [78] M. Liu, L. Wu, X. Zhu, W. Shan, L. Li, Y. Cui, Y. Huang, Core-shell stability of nanoparticles plays an important role for overcoming the intestinal mucus and epithelium barrier, *J Mater Chem B*, 4 (2016) 5831-5841.
- [79] J.P. Montheard, M. Chatzopoulos, D. Chappard, 2-Hydroxyethyl Methacrylate (Hema) - Chemical-Properties and Applications in Biomedical Fields, *J Macromol Sci R M C*, C32 (1992) 1-34.
- [80] E.V. Hackl, V.V. Khutoryanskiy, I. Ermolina, Hydrogels based on copolymers of 2-hydroxyethylmethacrylate and 2-hydroxyethylacrylate as a delivery system for proteins: Interactions with lysozyme, *J Appl Polym Sci*, 134 (2017).
- [81] A. Muhlebach, S.G. Gaynor, K. Matyjaszewski, Synthesis of amphiphilic block copolymers by atom transfer radical polymerization (ATRP), *Macromolecules*, 31 (1998) 6046-6052.
- [82] K. Bian, M.F. Cunningham, Nitroxide-mediated living radical polymerization of 2-hydroxyethyl acrylate and the synthesis of amphiphilic block copolymers, *Macromolecules*, 38 (2005) 695-701.
- [83] H. Kakwere, S. Perrier, Facile Synthesis of Star-Shaped Copolymers via Combination of RAFT and Ring Opening Polymerization, *J Polym Sci Pol Chem*, 47 (2009) 6396-6408.
- [84] M. Gosecki, M. Gadzinowski, M. Gosecka, T. Basinska, S. Slomkowski, Polyglycidol, Its Derivatives, and Polyglycidol-Containing Copolymers - Synthesis and Medical Applications, *Polymers-Basel*, 8 (2016).
- [85] R.K. Kainthan, J. Janzen, E. Levin, D.V. Devine, D.E. Brooks, Biocompatibility testing of branched and linear polyglycidol, *Biomacromolecules*, 7 (2006) 703-709.
- [86] C. Siegers, M. Biesalski, R. Haag, Self-assembled monolayers of dendritic polyglycerol derivatives on gold that resist the adsorption of proteins, *Chem-Eur J*, 10 (2004) 2831-2838.
- [87] Z. Amoozgar, Y. Yeo, Recent advances in stealth coating of nanoparticle drug delivery systems, *Wires Nanomed Nanobi*, 4 (2012) 219-233.
- [88] M.T. Cook, S.L. Smith, V.V. Khutoryanskiy, Novel glycopolymer hydrogels as mucosa-mimetic materials to reduce animal testing, *Chem Commun*, 51 (2015) 14447-14450.
- [89] P. Tonglairoum, R.P. Brannigan, P. Opanasopit, V.V. Khutoryanskiy, Maleimide-bearing nanogels as novel mucoadhesive materials for drug delivery, *J Mater Chem B*, 4 (2016) 6581-6587.
- [90] C.T. Nordgard, U. Nonstad, M.O. Olderoy, T. Espevik, K.I. Draget, Alterations in Mucus Barrier Function and Matrix Structure Induced by Gulturonate Oligomers, *Biomacromolecules*, 15 (2014) 2294-2300.
- [91] A.B. Lowe, C.L. McCormick, Synthesis and solution properties of zwitterionic polymers, *Chem Rev*, 102 (2002) 4177-4189.
- [92] S. Kudaibergenov, W. Jaeger, A. Laschewsky, Polymeric betaines: Synthesis, characterization, and application, *Adv Polym Sci*, 201 (2006) 157-224.
- [93] A. Laschewsky, Structures and Synthesis of Zwitterionic Polymers, *Polymers-Basel*, 6 (2014) 1544-1601.
- [94] W. Yang, L. Zhang, S.L. Wang, A.D. White, S.Y. Jiang, Functionalizable and ultra stable nanoparticles coated with zwitterionic poly(carboxybetaine) in undiluted blood serum, *Biomaterials*, 30 (2009) 5617-5621.

- [95] W. Shan, X. Zhu, W. Tao, Y. Cui, M. Liu, L. Wu, L. Li, Y.X. Zheng, Y. Huang, Enhanced Oral Delivery of Protein Drugs Using Zwitterion-Functionalized Nanoparticles to Overcome both the Diffusion and Absorption Barriers, *ACS Appl Mater Inter*, 8 (2016) 25444-25453.
- [96] C. Muller, G. Perera, V. Konig, A. Bernkop-Schnurch, Development and in vivo evaluation of papain-functionalized nanoparticles, *Eur J Pharm Biopharm*, 87 (2014) 125-131.
- [97] I.P. de Sousa, B. Cattoz, M.D. Wilcox, P.C. Griffiths, R. Dalgliesh, S. Rogers, A. Bernkop-Schnurch, Nanoparticles decorated with proteolytic enzymes, a promising strategy to overcome the mucus barrier, *Eur J Pharm Biopharm*, 97 (2015) 257-264.
- [98] I.P. de Sousa, C. Steiner, M. Schmutzler, M.D. Wilcox, G.J. Veldhuis, J.P. Pearson, C.W. Huck, W. Salvenmoser, A. Bernkop-Schnurch, Mucus permeating carriers: formulation and characterization of highly densely charged nanoparticles, *Eur J Pharm Biopharm*, 97 (2015) 273-279.
- [99] P. Occhipinti, P.C. Griffiths, Quantifying diffusion in mucosal systems by pulsed-gradient spin-echo NMR, *Adv Drug Deliver Rev*, 60 (2008) 1570-1582.
- [100] S. Grund, M. Bauer, D. Fischer, Polymers in Drug Delivery-State of the Art and Future Trends, *Adv Eng Mater*, 13 (2011) B61-B87.
- [101] F.M. Veronese, G. Pasut, PEGylation, successful approach to drug delivery, *Drug discovery today*, 10 (2005) 1451-1458.
- [102] Y. Chen, B. Pidhatika, T. von Erlach, R. Konradi, M. Textor, H. Hall, T. Luhmann, Comparative assessment of the stability of nonfouling poly(2-methyl-2-oxazoline) and poly(ethylene glycol) surface films: An in vitro cell culture study, *Biointerphases*, 9 (2014).
- [103] F.C. Gaertner, R. Luxenhofer, B. Blechert, R. Jordan, M. Essler, Synthesis, biodistribution and excretion of radiolabeled poly(2-alkyl-2-oxazoline)s, *J Control Release*, 119 (2007) 291-300.
- [104] R. Duncan, Development of HPMA copolymer-anticancer conjugates: Clinical experience and lessons learnt, *Adv Drug Deliver Rev*, 61 (2009) 1131-1148.
- [105] P. Goddard, I. Williamson, J. Brown, L.E. Hutchinson, J. Nicholls, K. Petrak, Soluble Polymeric Carriers for Drug Delivery .4. Tissue Autoradiography, and Whole-Body Tissue Distribution in Mice, of N-(2-Hydroxypropyl)Methacrylamide Copolymers Following Intravenous Administration, *J Bioact Compat Pol*, 6 (1991) 4-24.
- [106] K. Maruyama, S. Okuizumi, O. Ishida, H. Yamauchi, H. Kikuchi, M. Iwatsuru, Phosphatidyl Polyglycerols Prolong Liposome Circulation in-Vivo, *Int J Pharmaceut*, 111 (1994) 103-107.
- [107] S. Salmaso, P. Caliceti, Stealth properties to improve therapeutic efficacy of drug nanocarriers, *Journal of drug delivery*, 2013 (2013) 374252.